

Hymor Timber Limited

Scotia Business Park, Scotia Road, Tunstall, Stoke-on-Trent, Staffs, ST6 4HG

Telephone 01782 836636

E-Mail: enquiries@hymortimber.co.uk

Fax 01782 837353

www.hymortimber.co.uk

Catalogue of Mouldings 2012

Hymor Timber Limited Catalogue of Standard Mouldings 2012

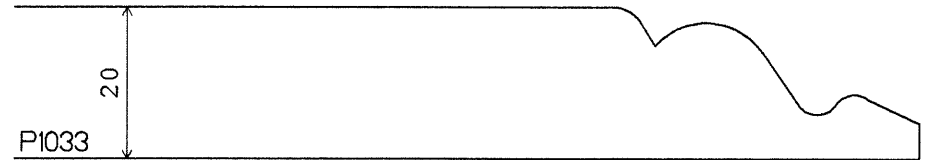
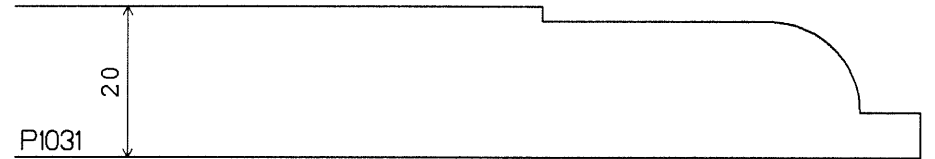
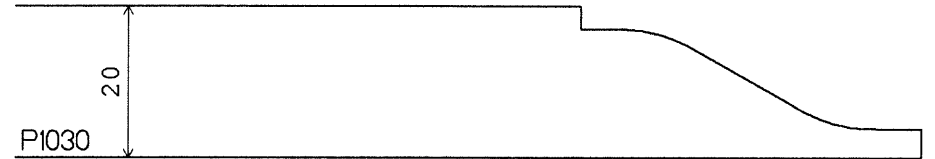
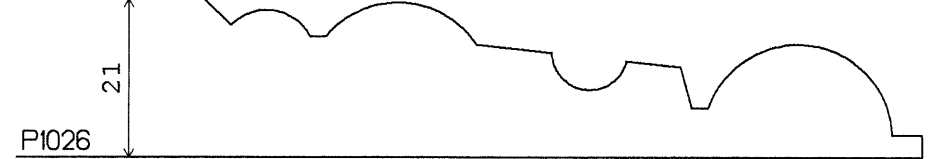
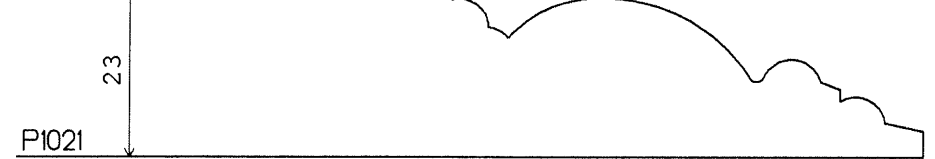
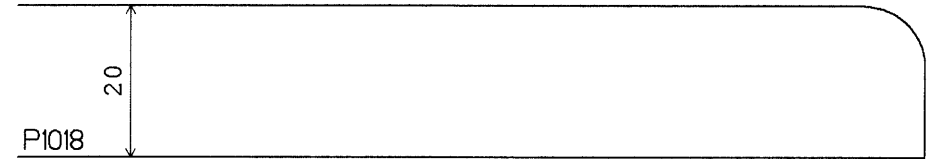
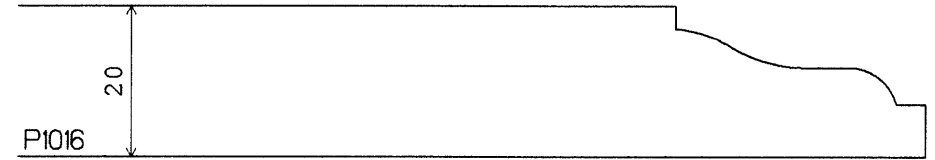
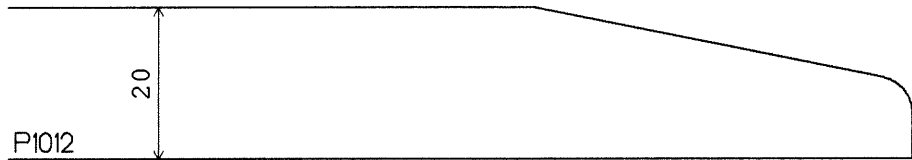
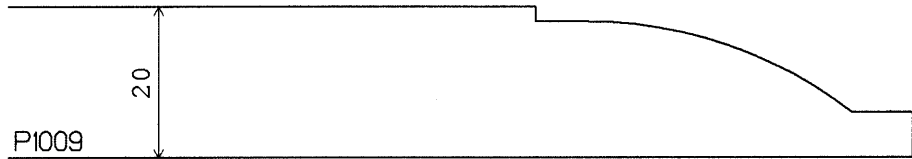
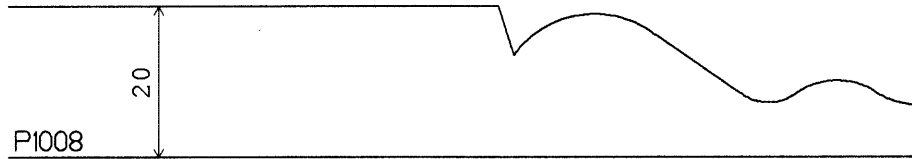
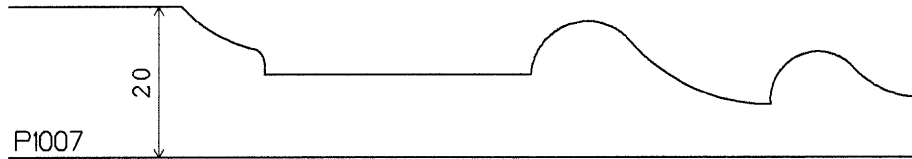
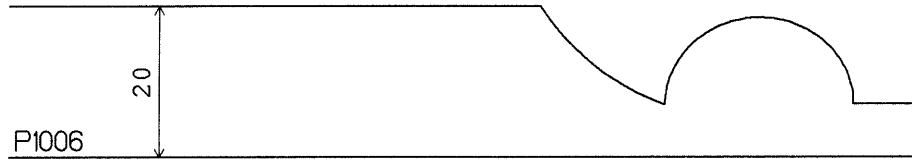
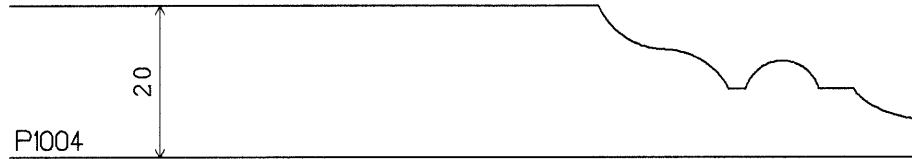
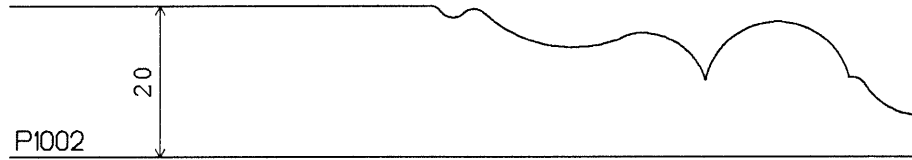

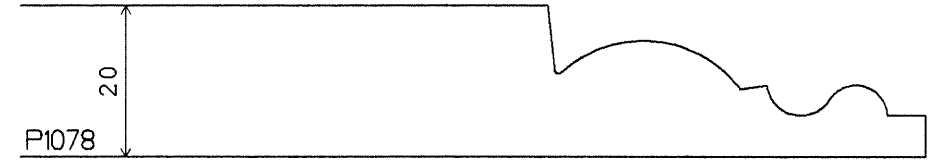
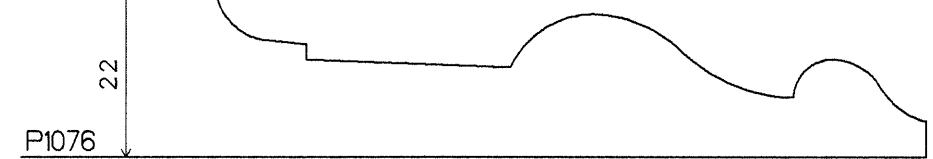
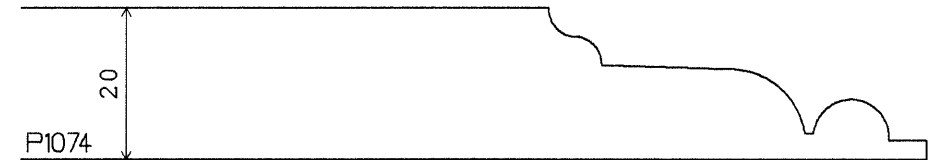
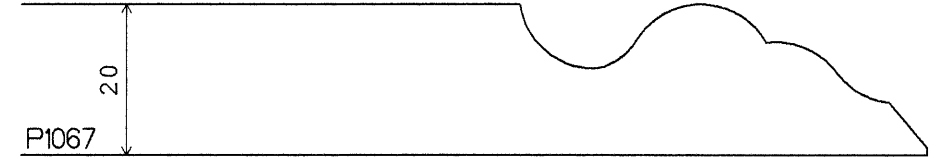
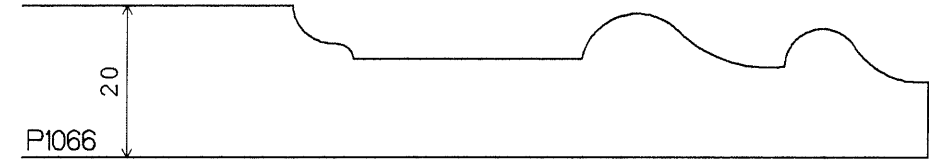
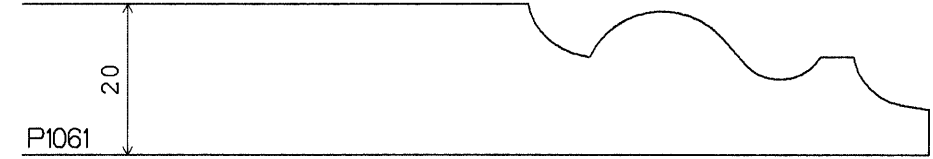
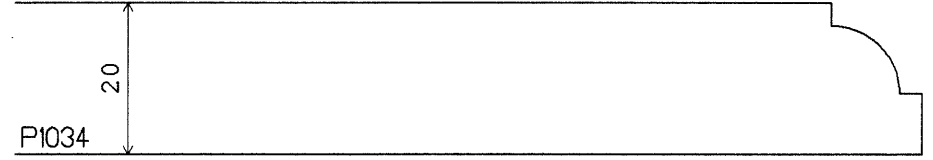
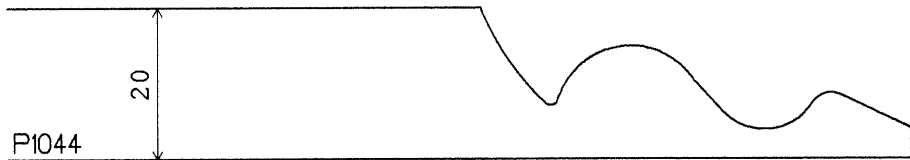
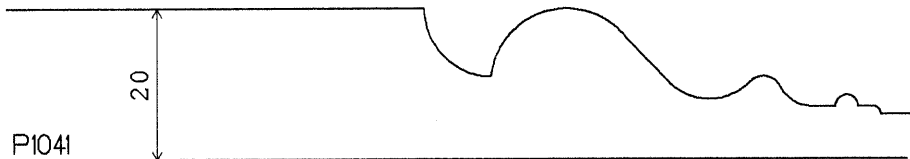
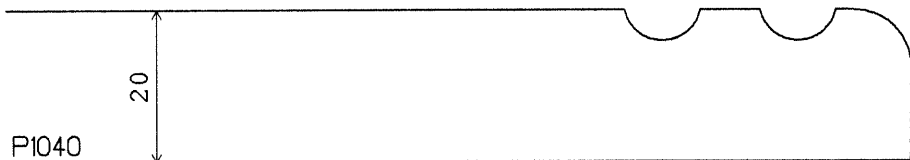
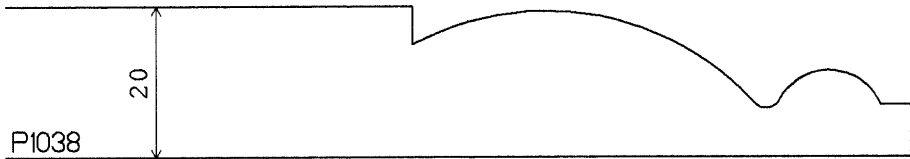
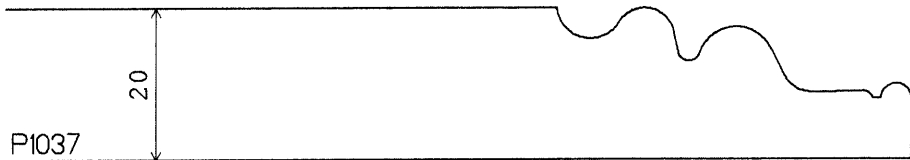
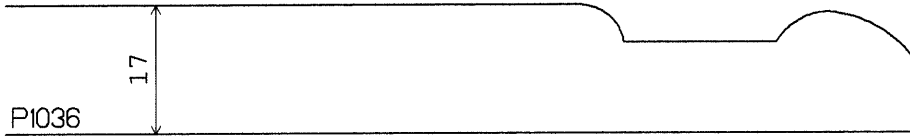
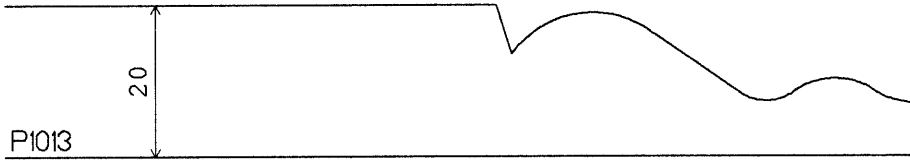

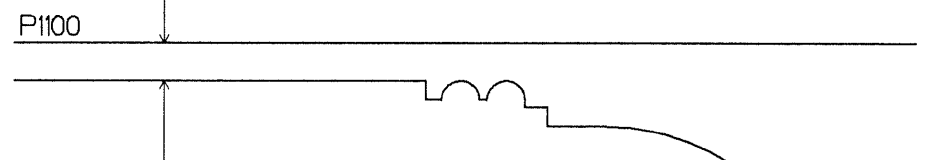
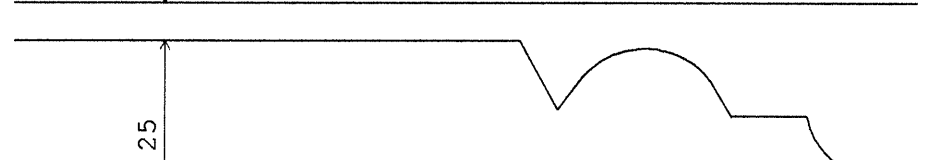
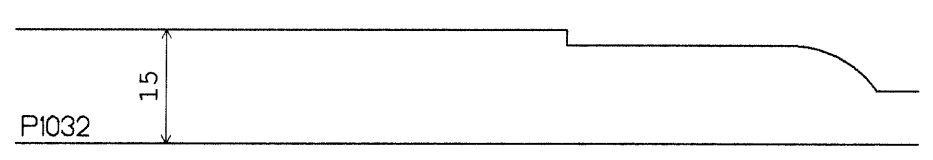
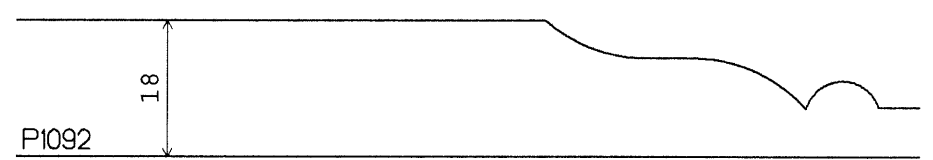
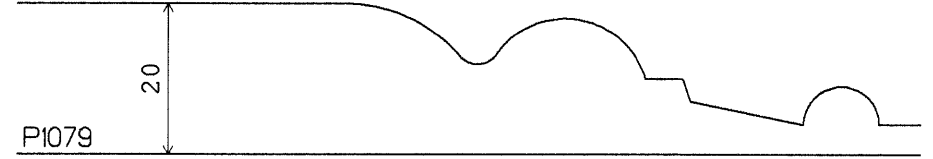
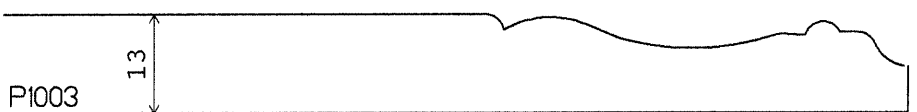
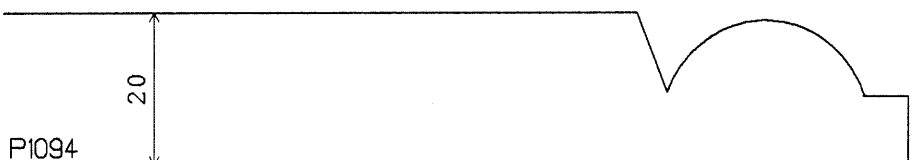
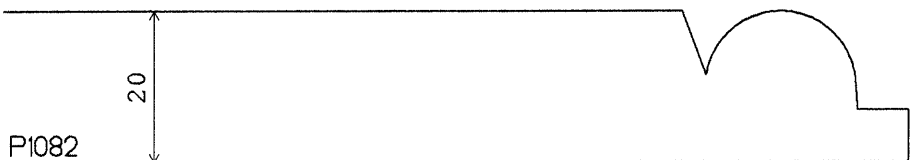
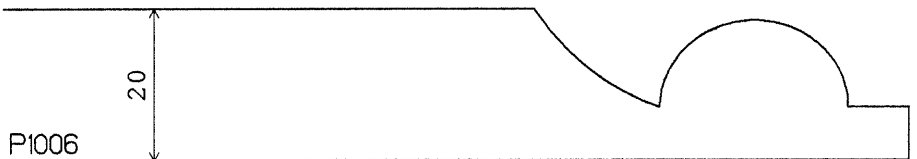
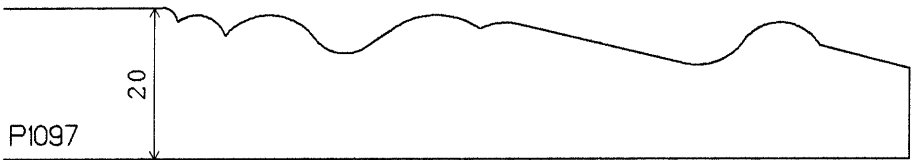
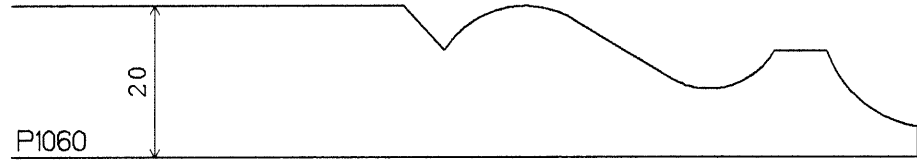
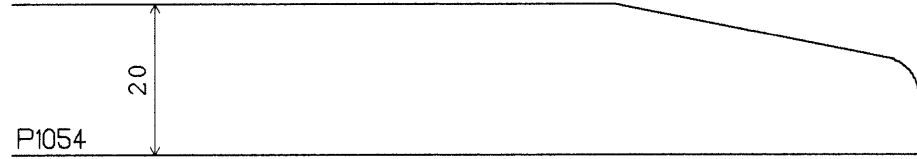

Hymor Timber Limited Catalogue of Standard Mouldings 2012

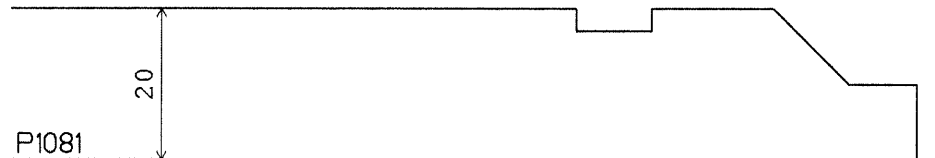
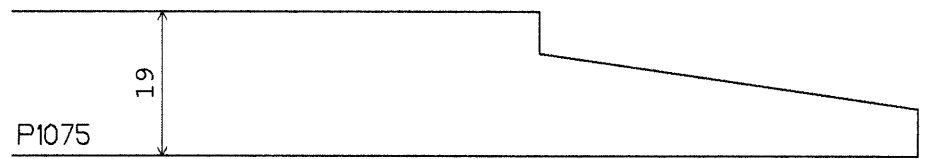
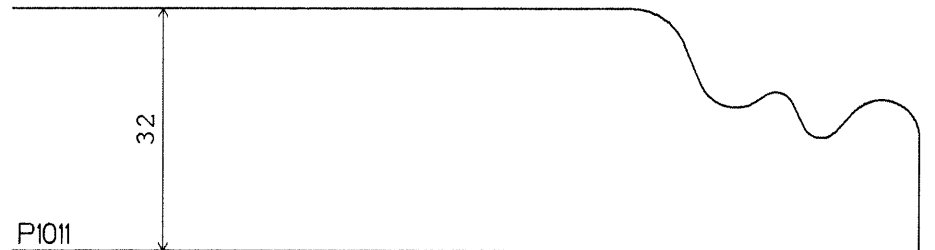
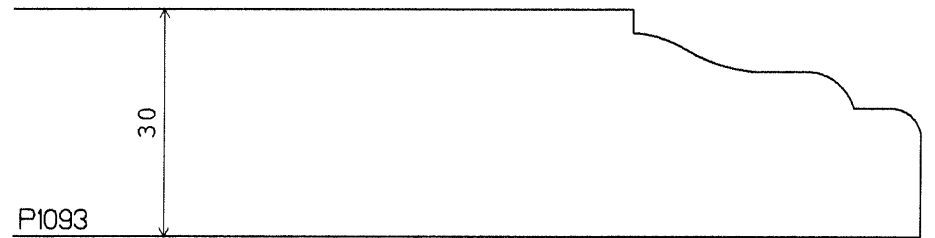
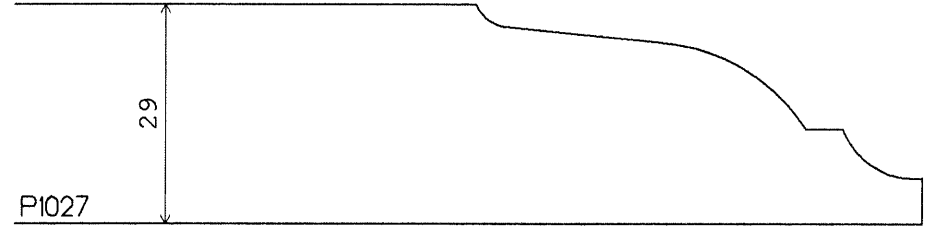
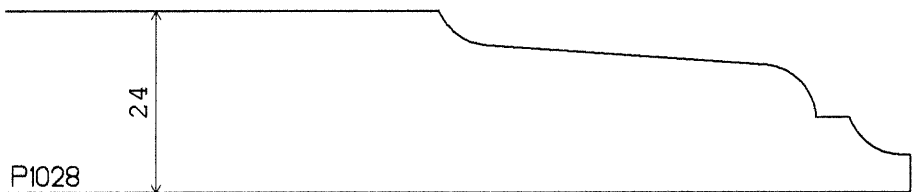
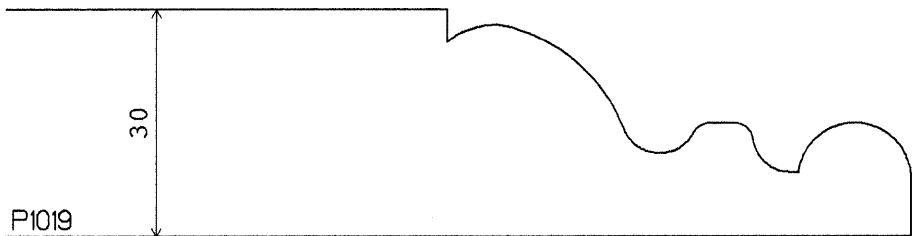
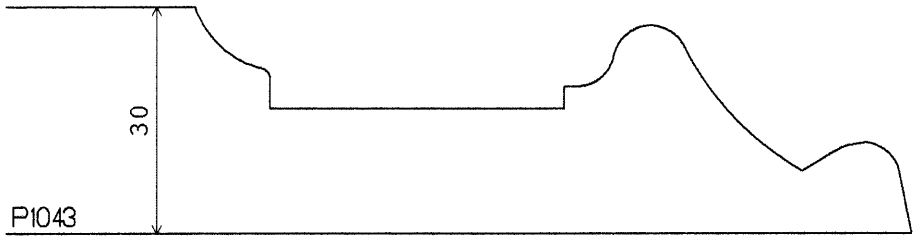
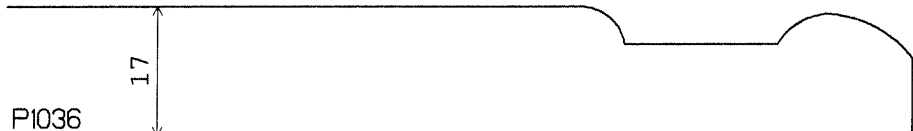
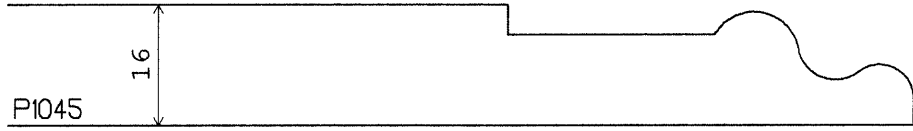

Hymor Timber Limited Catalogue of Standard Mouldings 2012

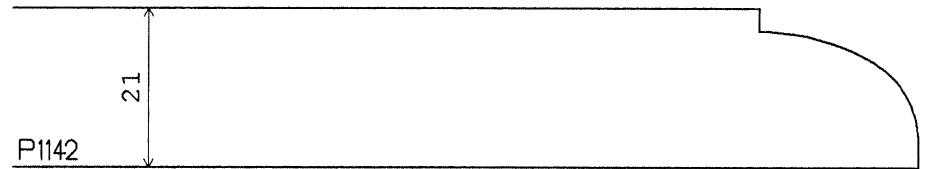
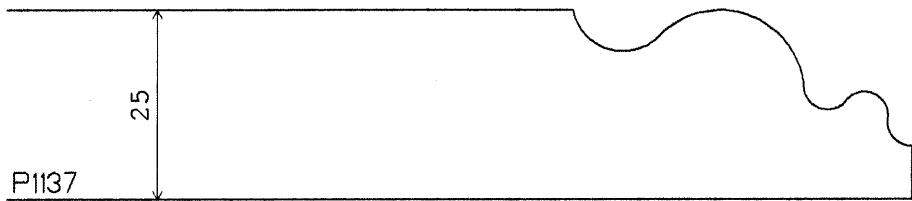
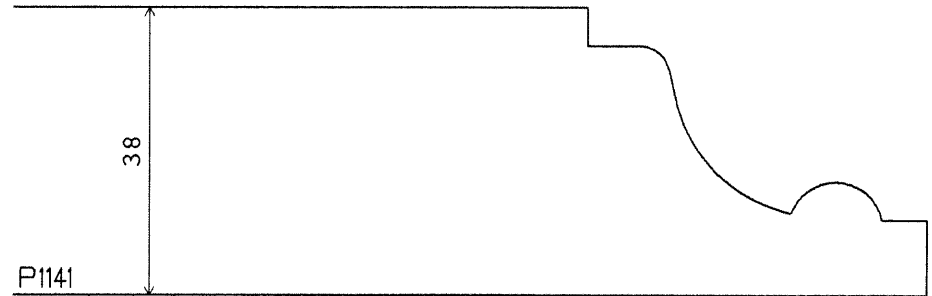
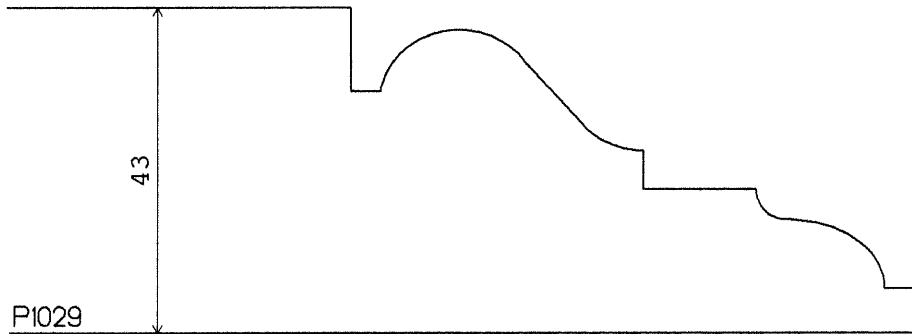
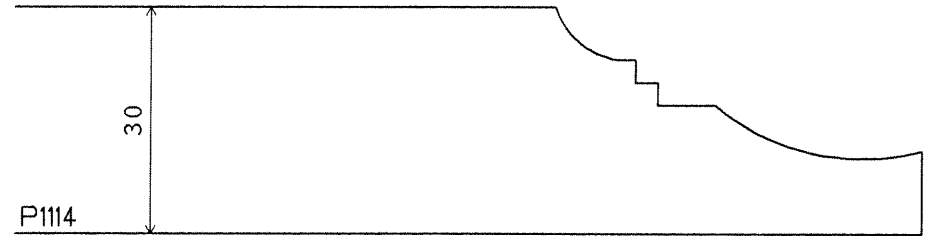
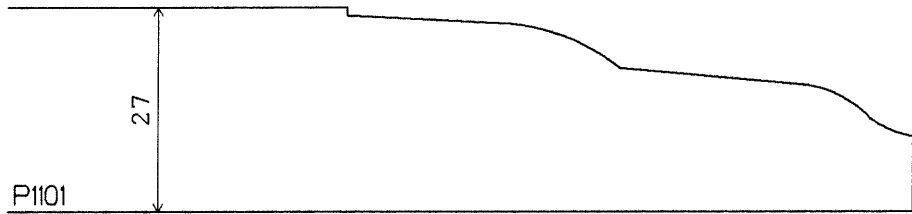
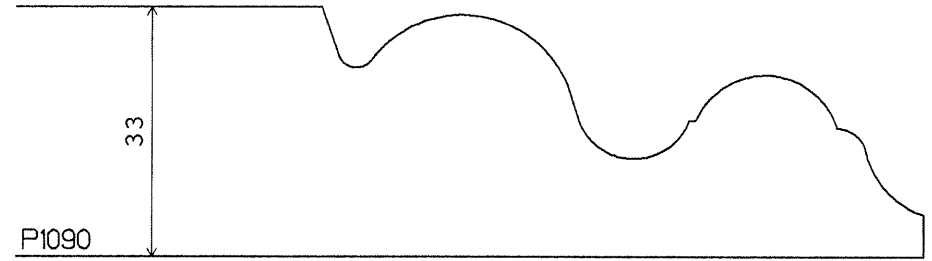
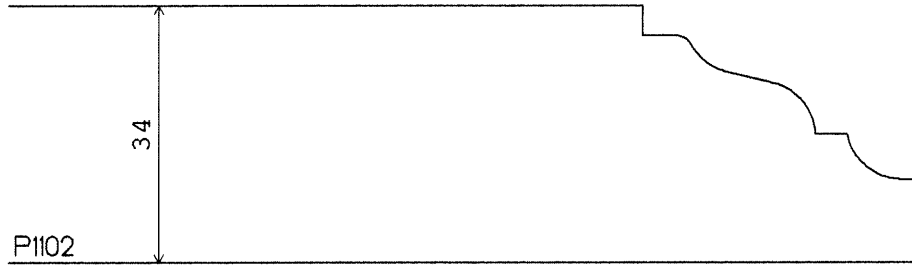

Hymor Timber Limited Catalogue of Standard Mouldings 2012

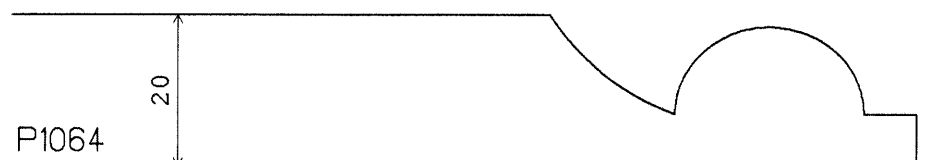
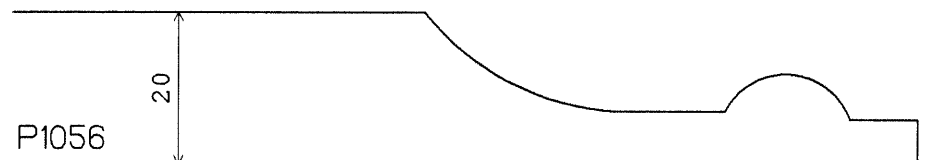
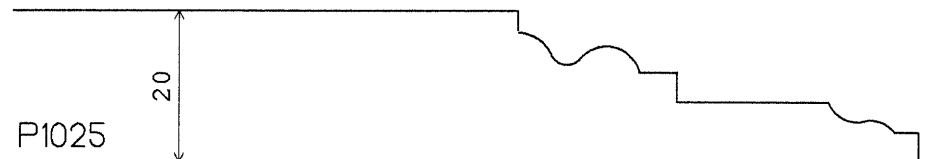
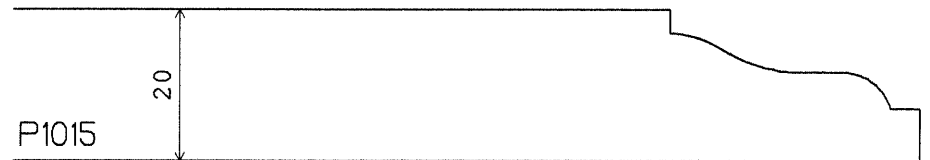
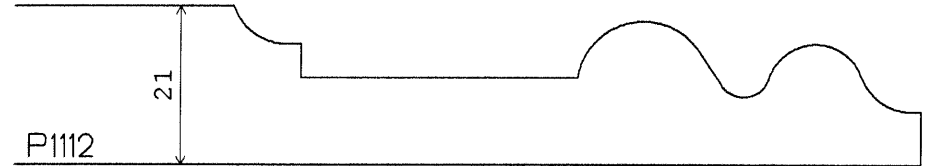
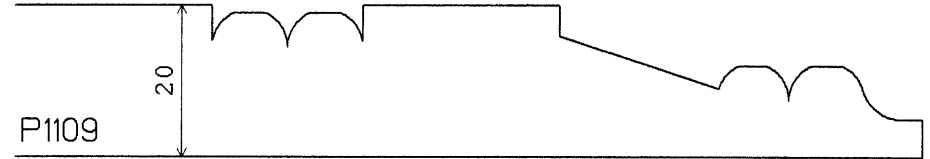
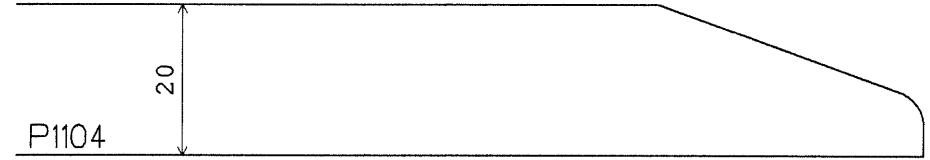
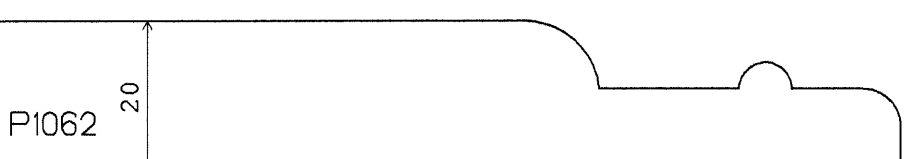
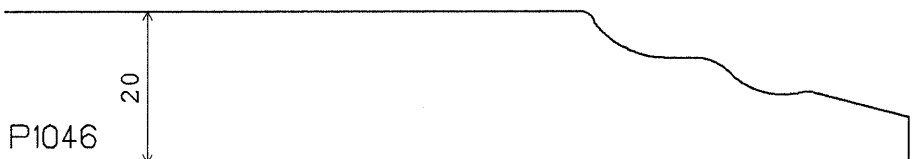
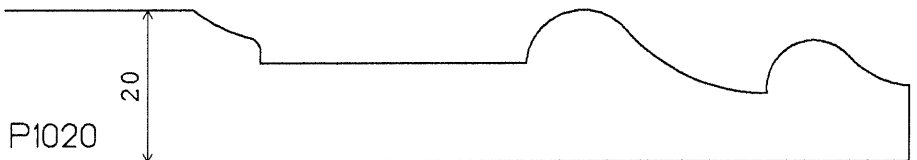
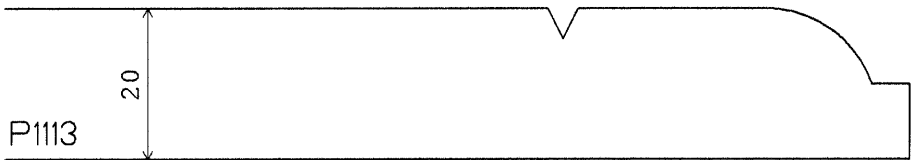
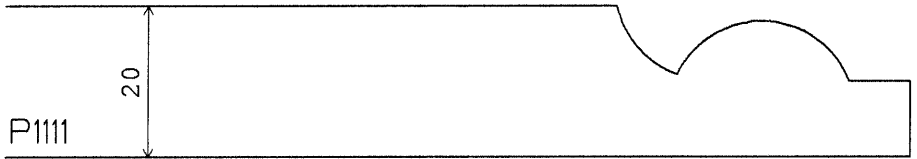
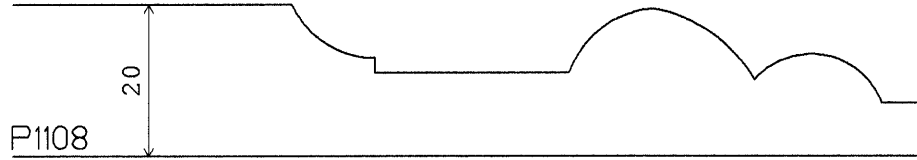

Hymor Timber Limited Catalogue of Standard Mouldings 2012

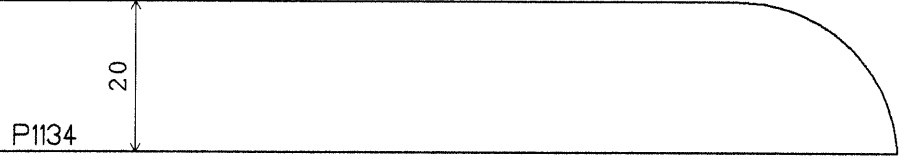
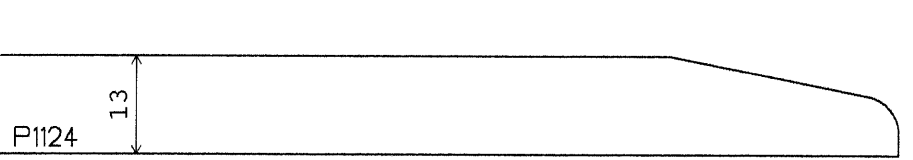
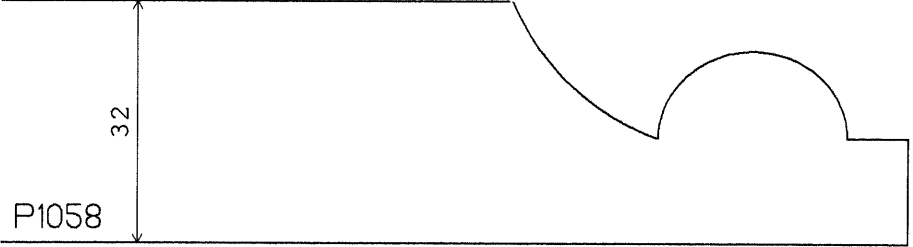
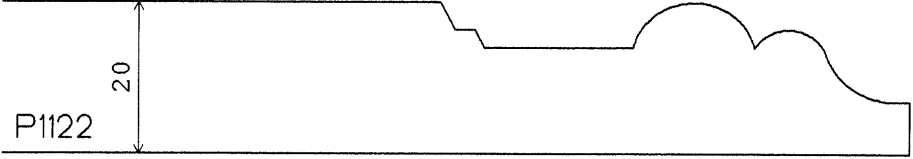
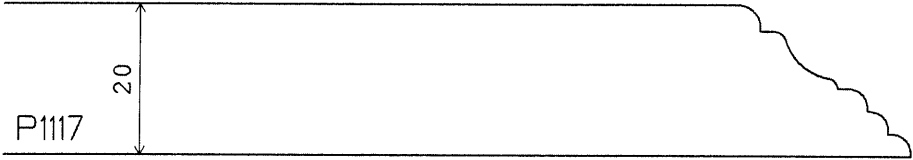
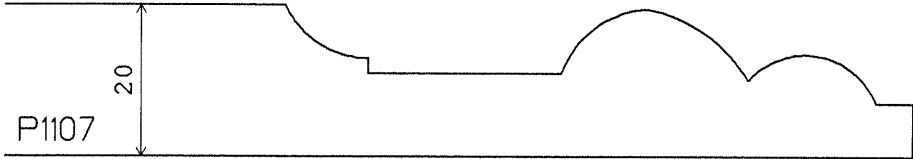
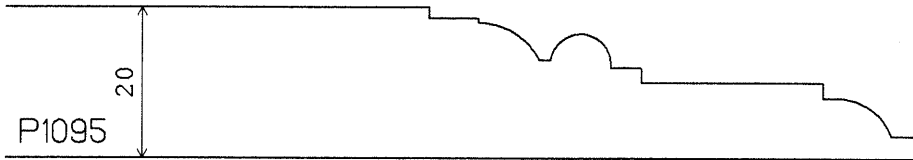
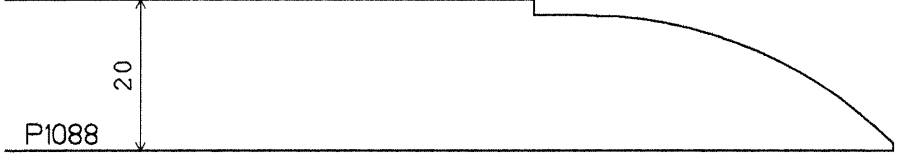
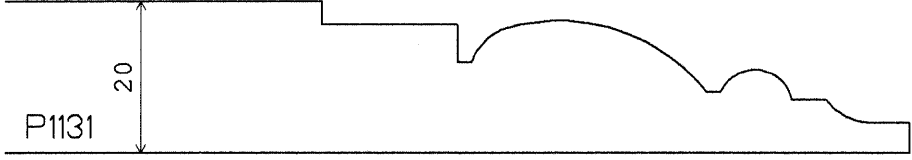
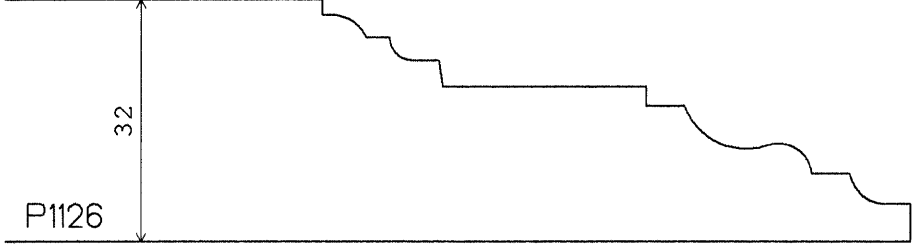
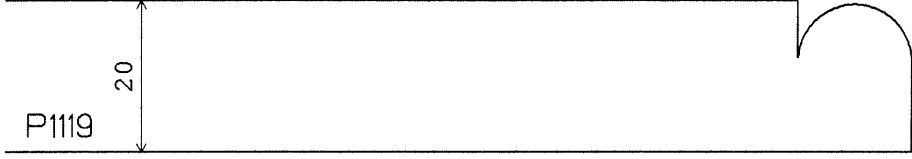
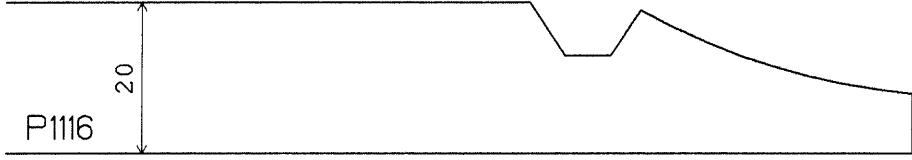
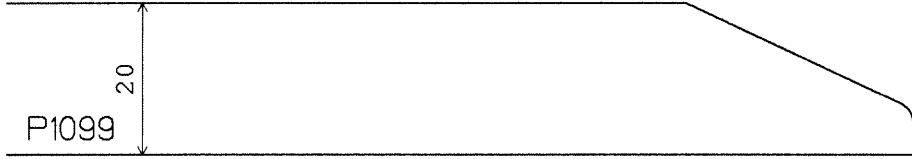
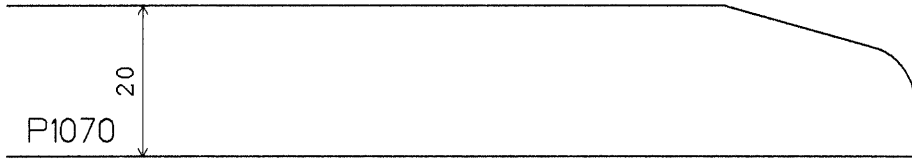

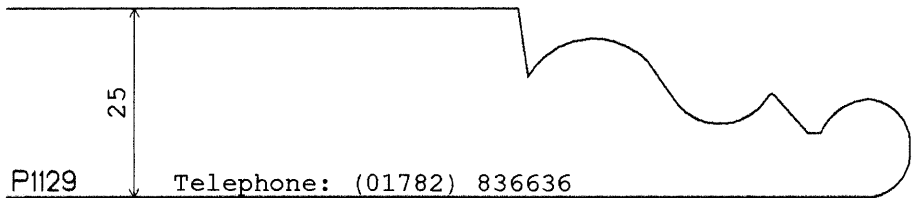
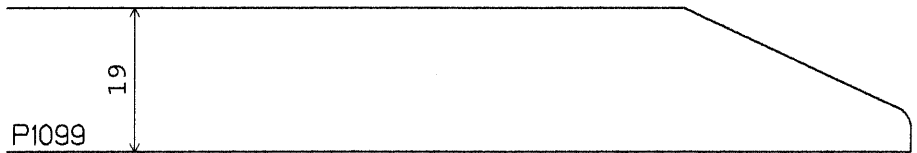
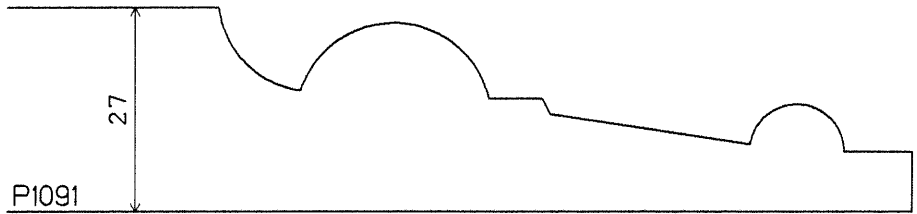
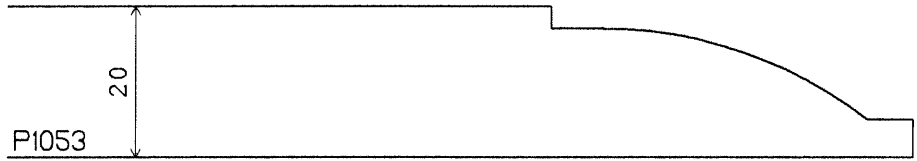
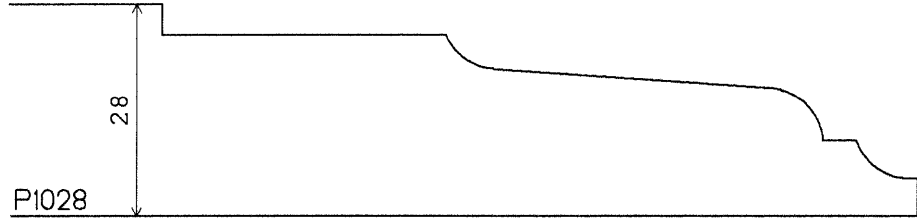
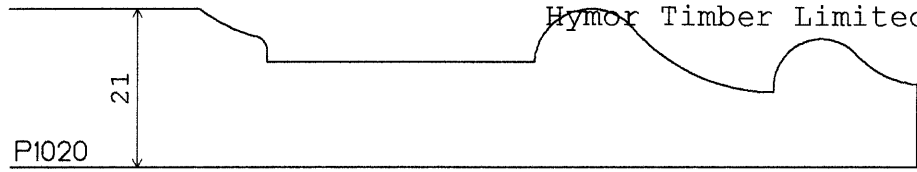

Telephone: (01782) 836636

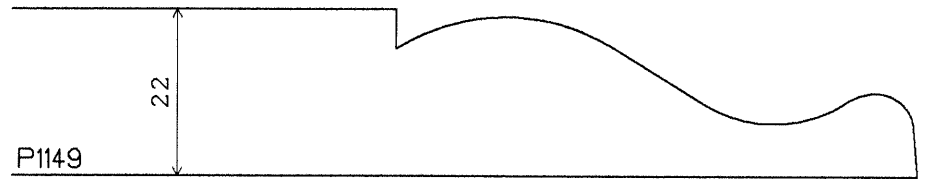
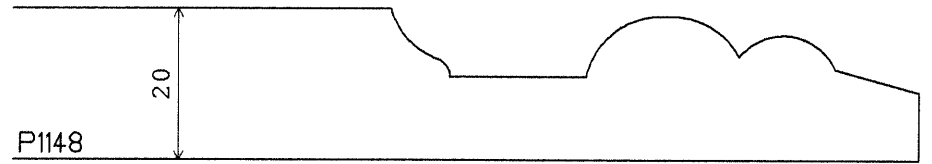
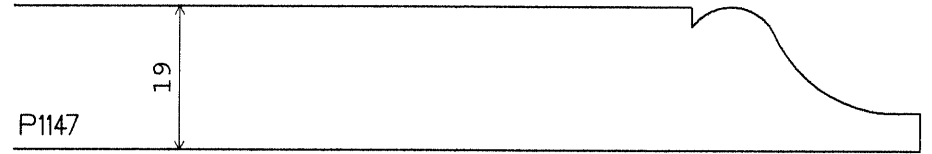
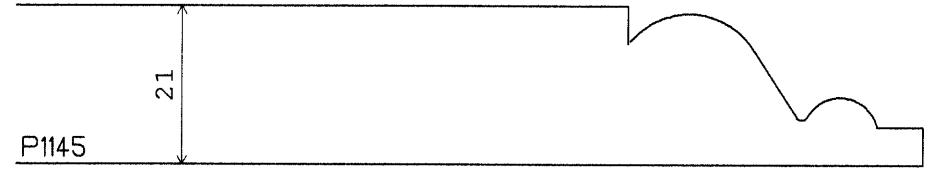
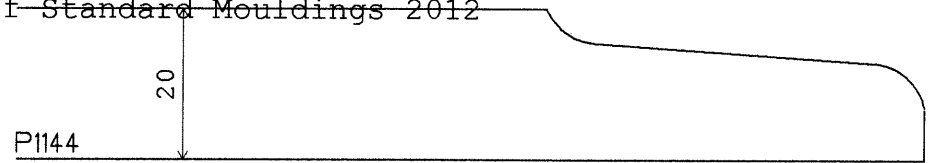

Fax: (01782) 837353

Hymor Timber Limited Catalogue of Standard Mouldings 2012

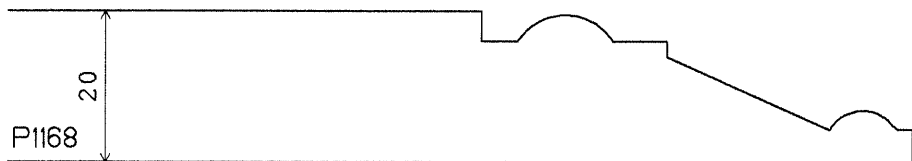
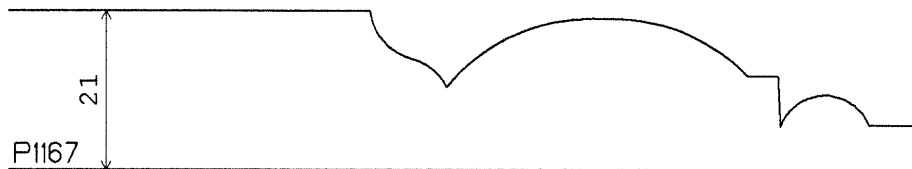
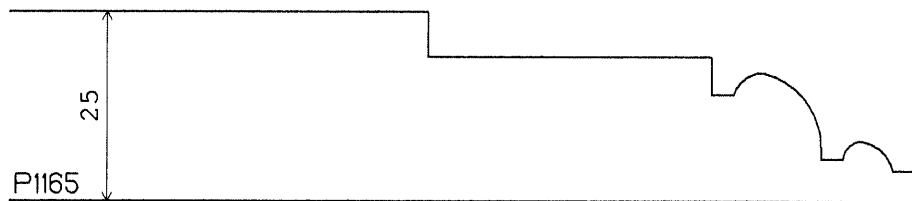
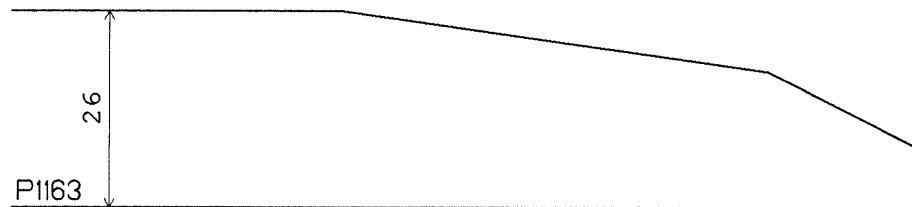
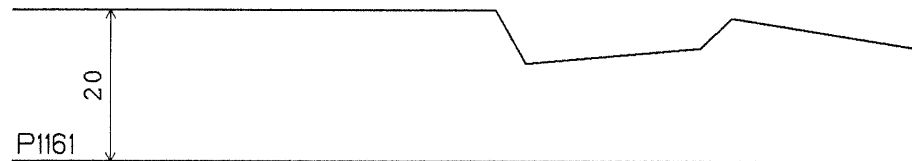
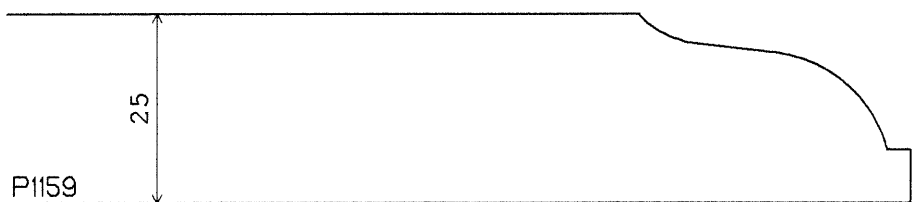
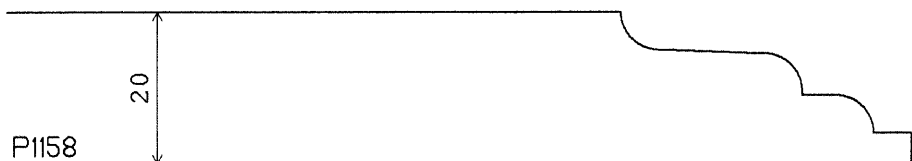
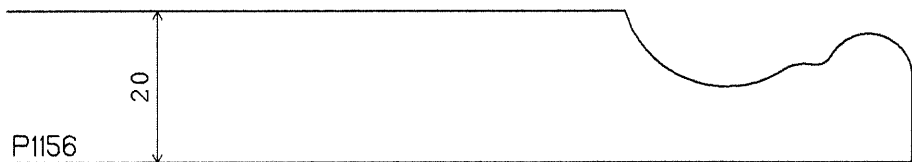
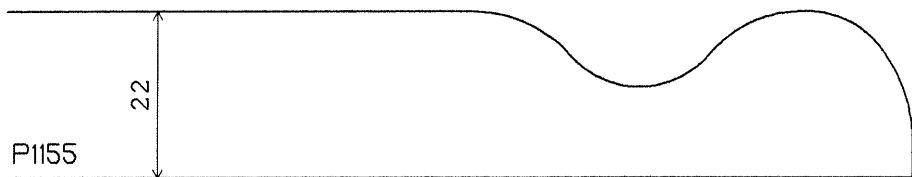
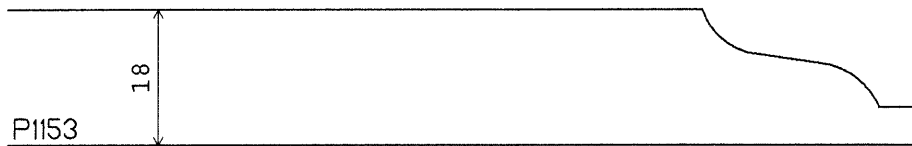
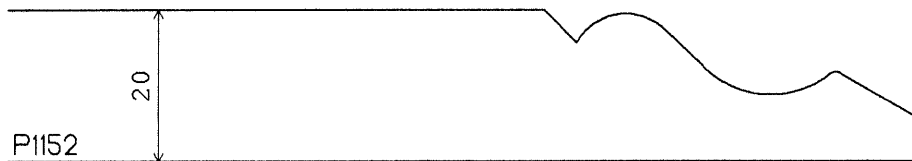

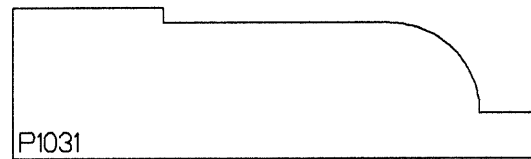
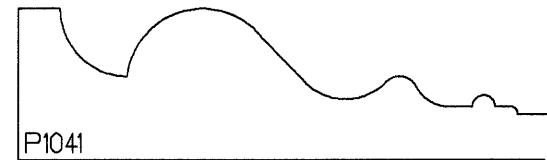
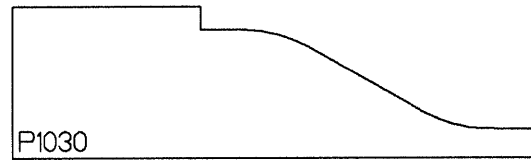
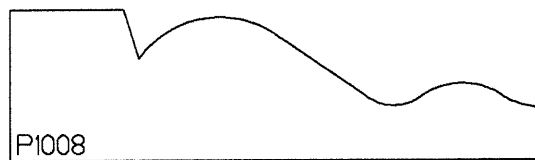
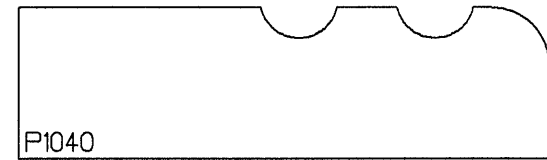
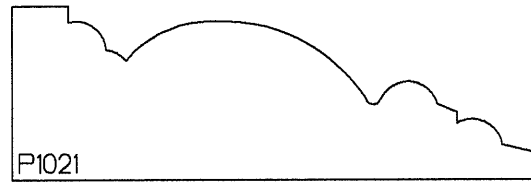
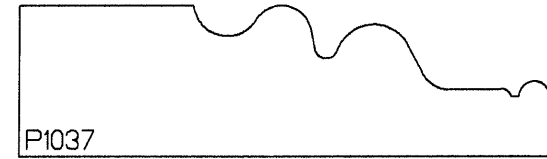
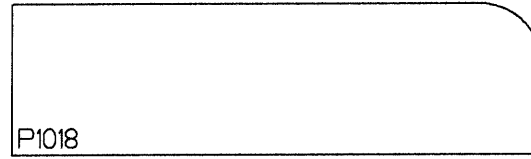
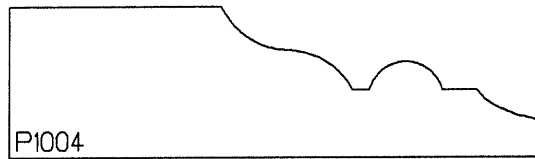
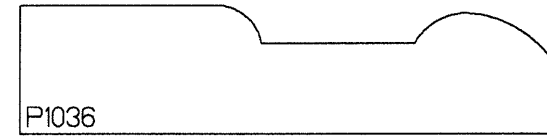
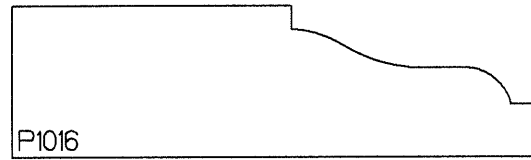
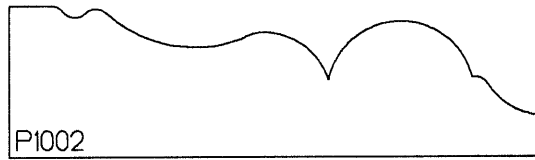

Hymor Timber Limited Catalogue of Standard Mouldings 2012

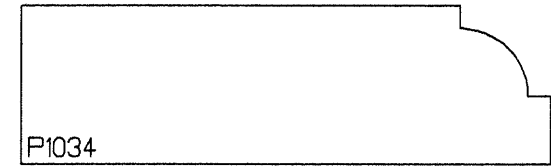
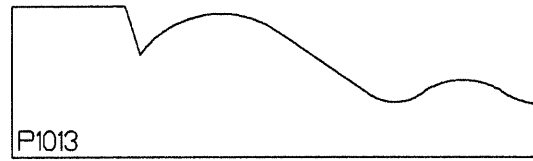
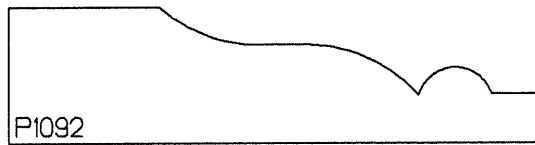
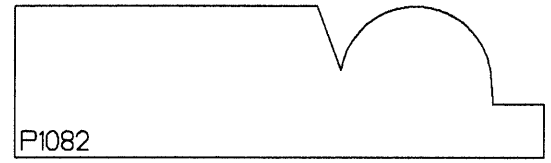
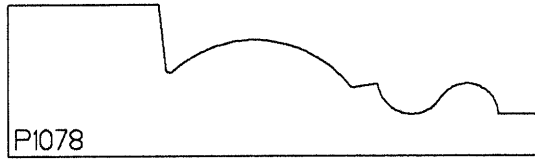
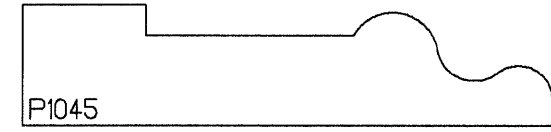
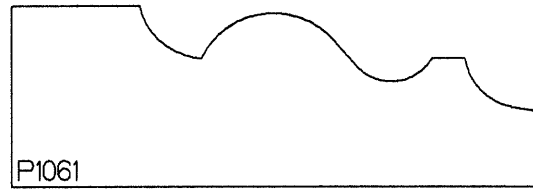
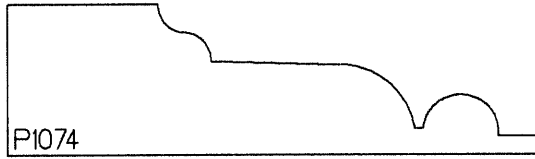
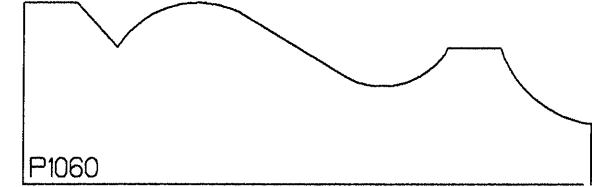
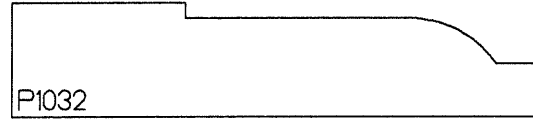
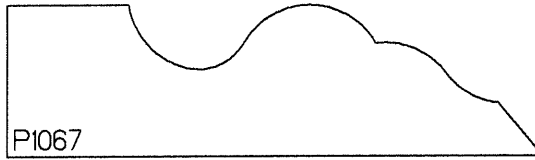
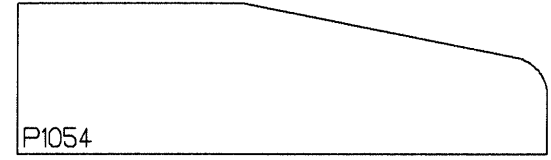
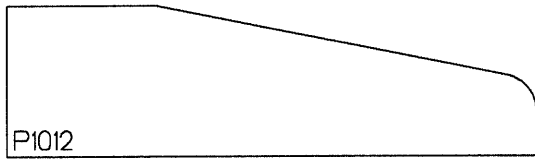

Hymor Timber Limited Catalogue of Standard Mouldings 2012

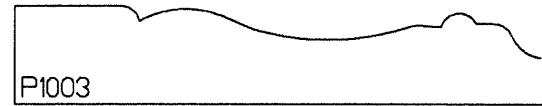
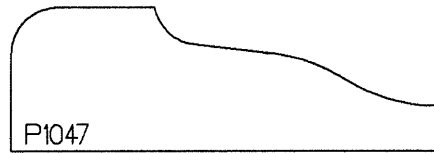
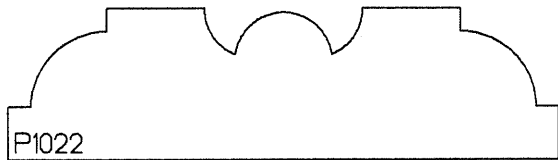
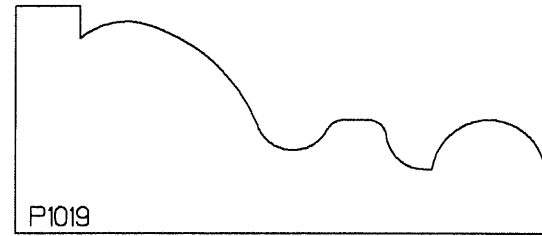
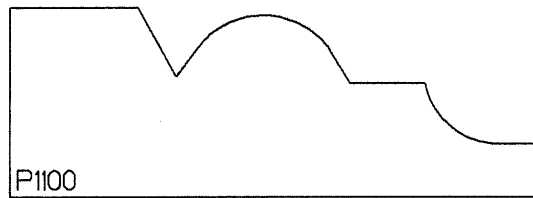
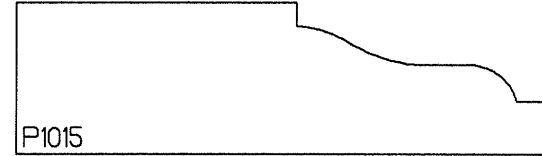
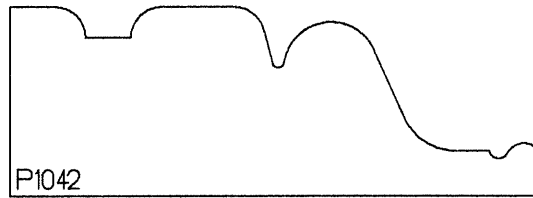
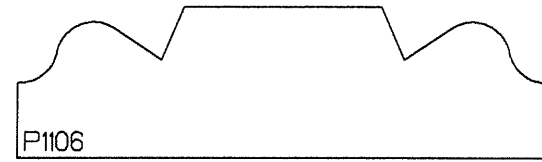
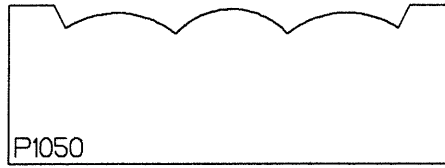
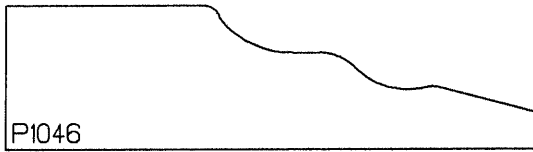
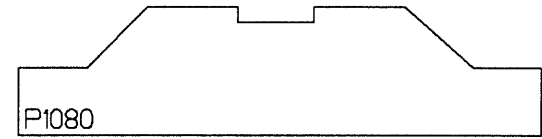
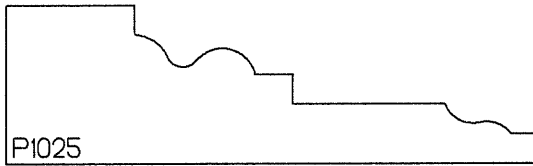

Hymor Timber Limited Catalogue of Standard Mouldings 2012

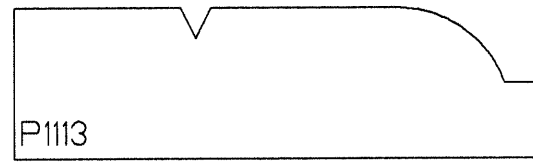
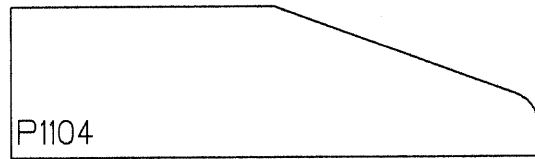
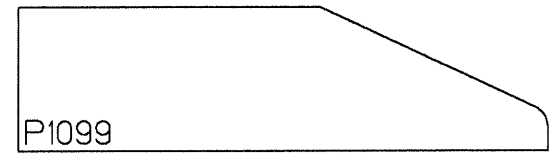
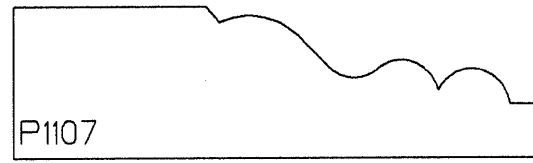
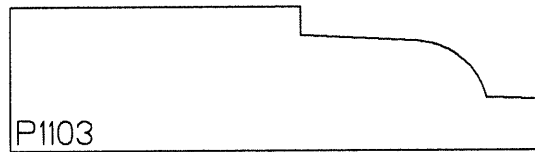
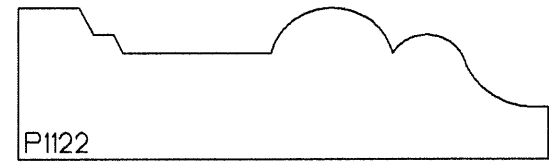
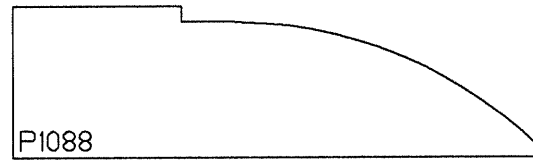
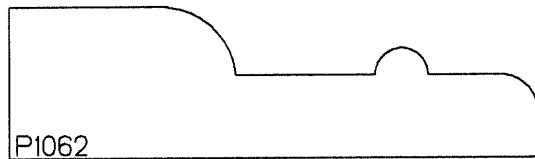
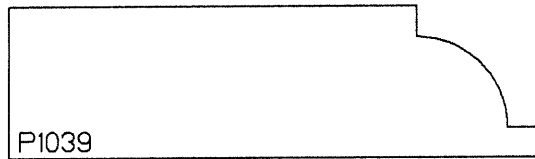
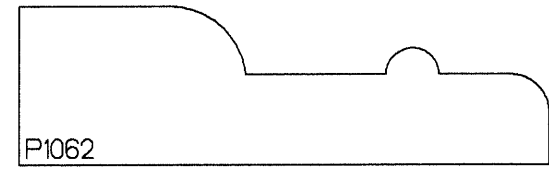
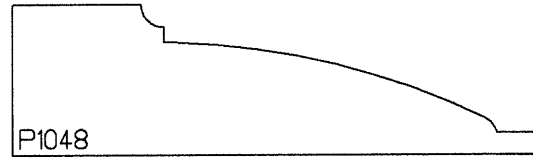
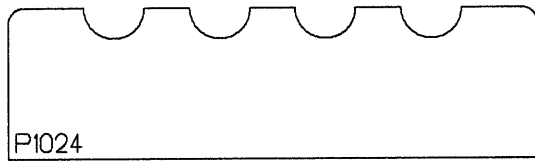

Hymor Timber Limited Catalogue of Standard Mouldings 2012

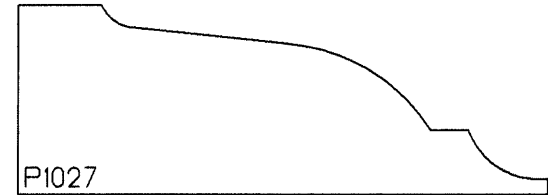
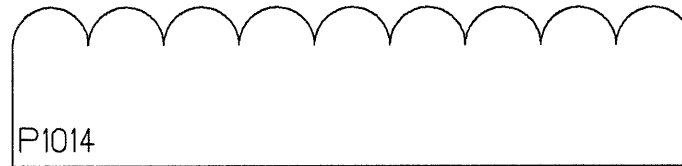
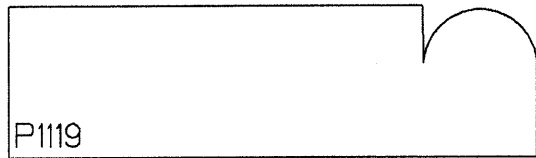
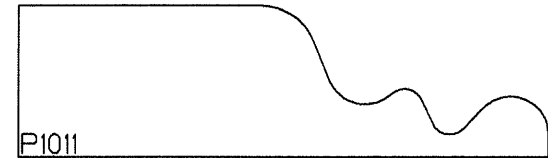
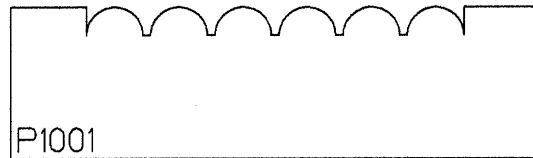
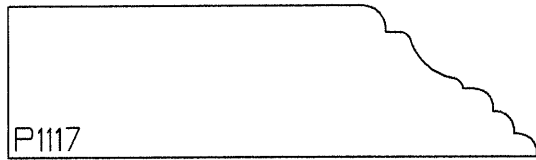
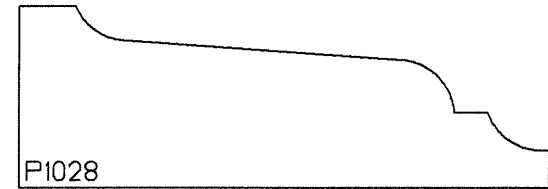
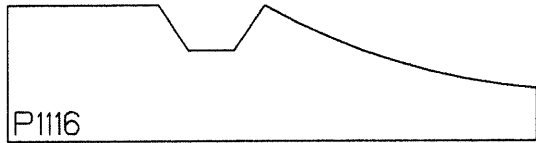
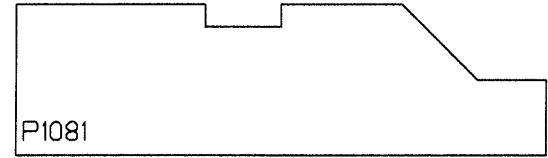
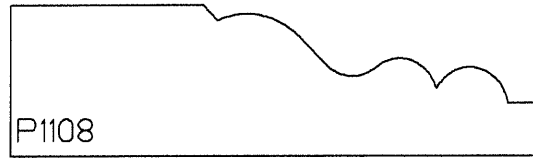
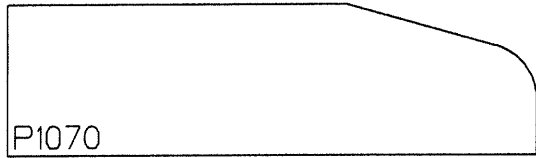
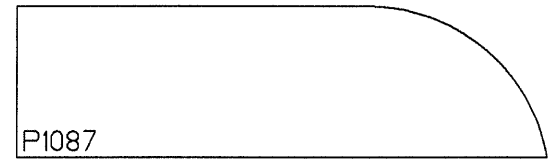
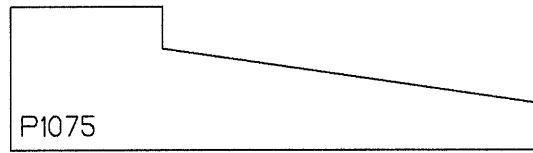
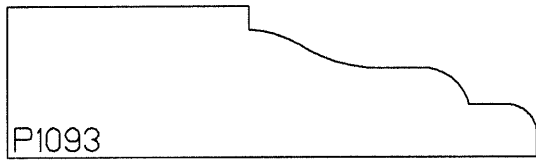

Hymor Timber Limited Catalogue of Standard Mouldings 2012

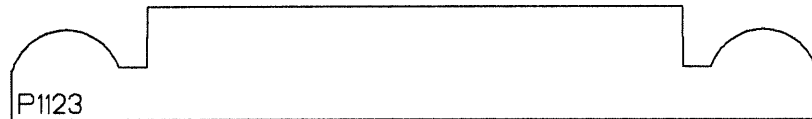
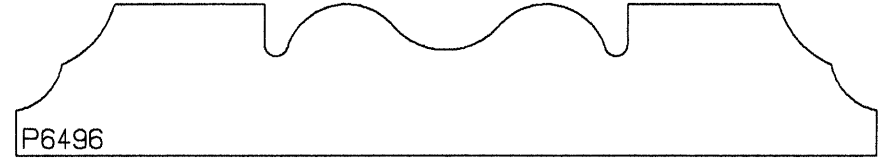
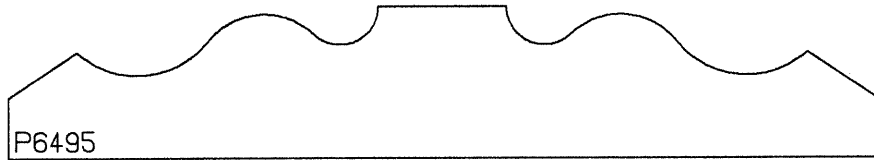
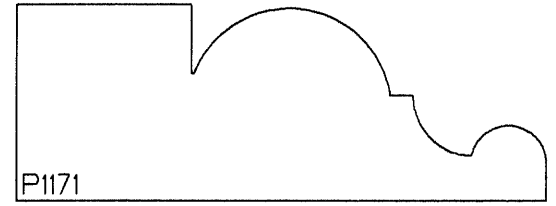
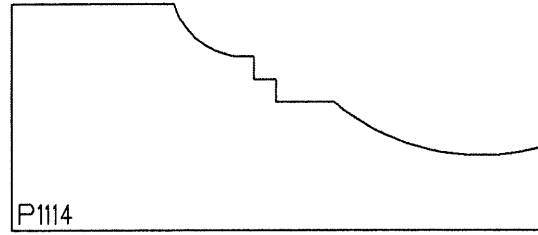
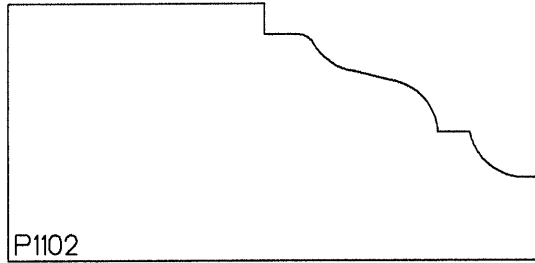
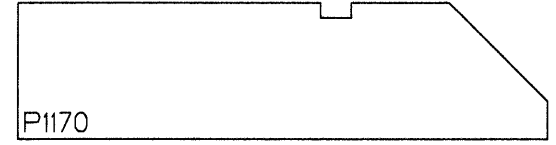
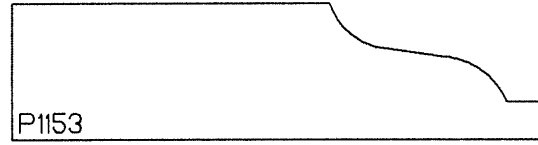
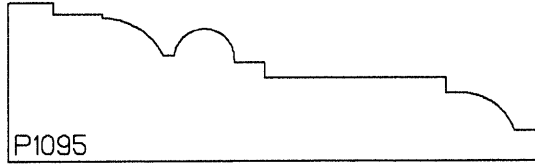
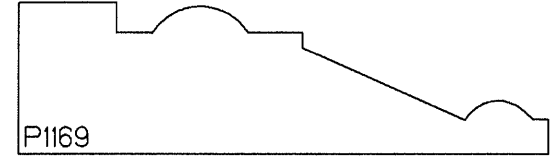
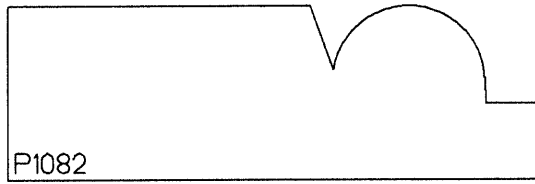

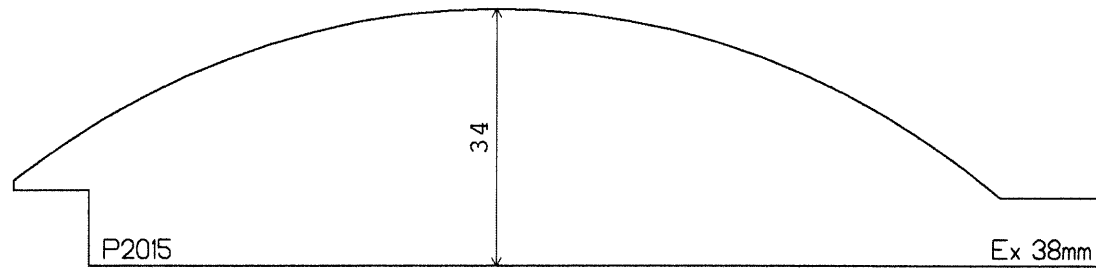
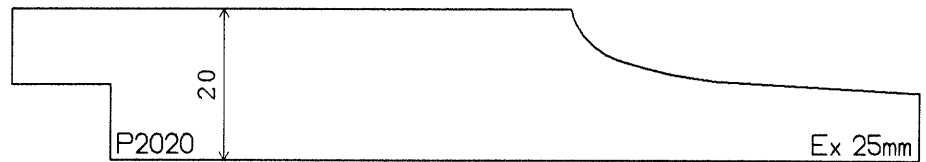
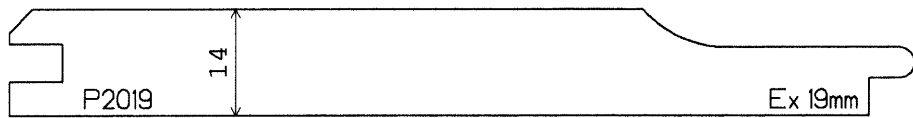
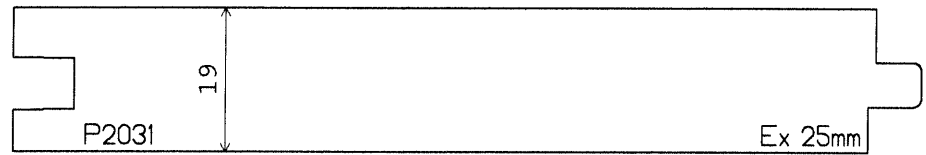
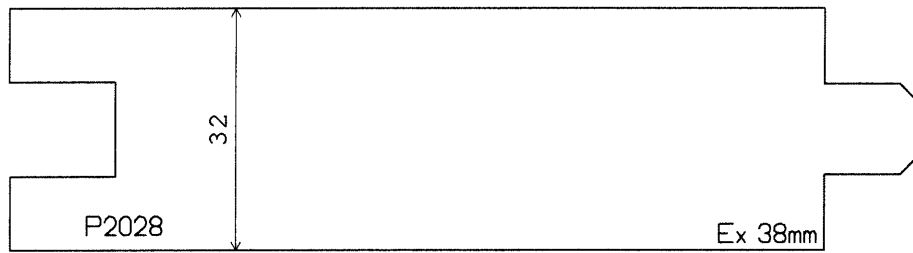
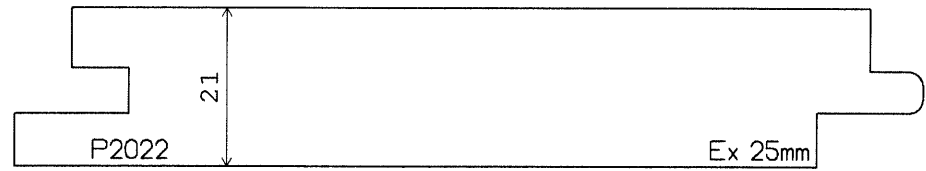
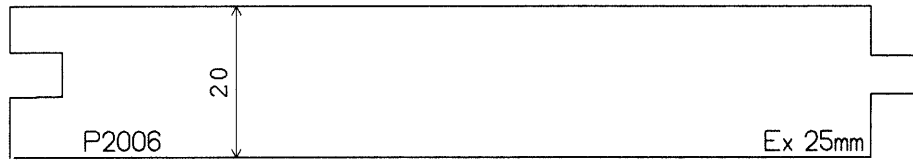

Hymor Timber Limited Catalogue of Standard Mouldings 2012

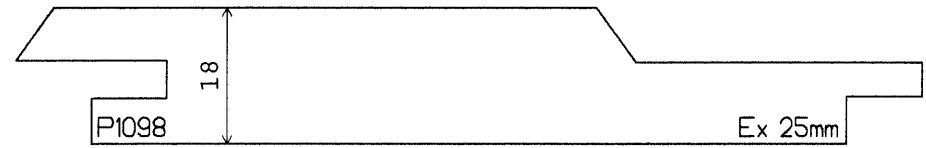
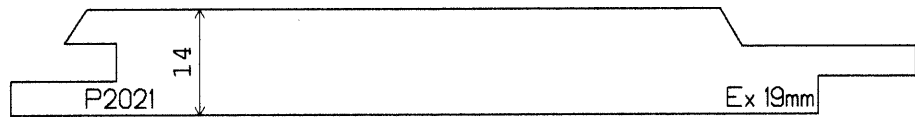
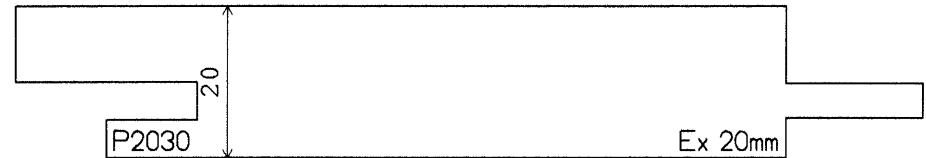
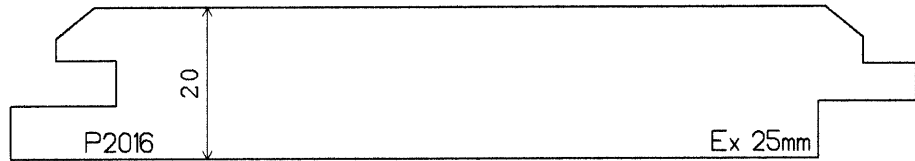
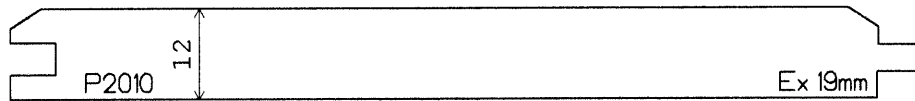
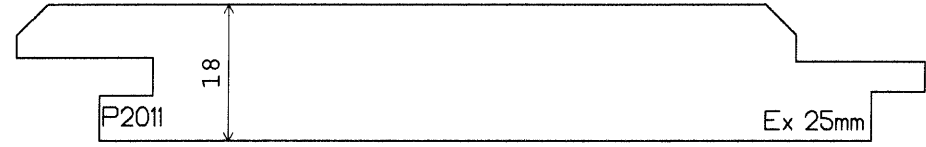
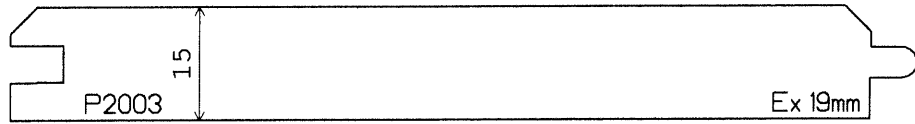
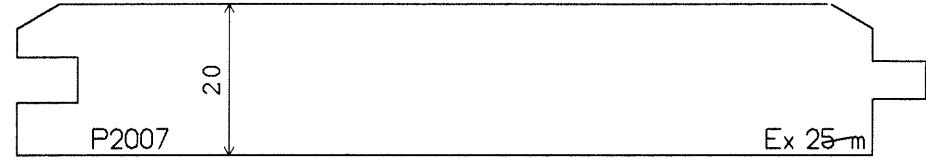
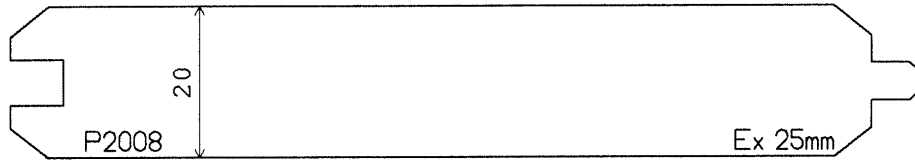

Hymor Timber Limited Catalogue of Standard Mouldings 2012

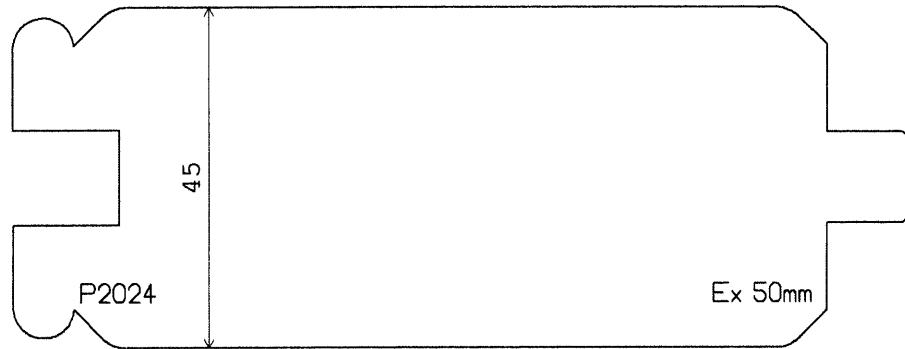
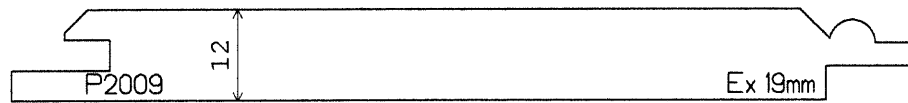
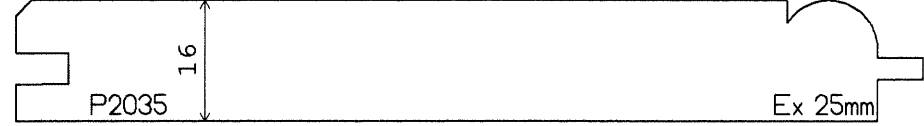
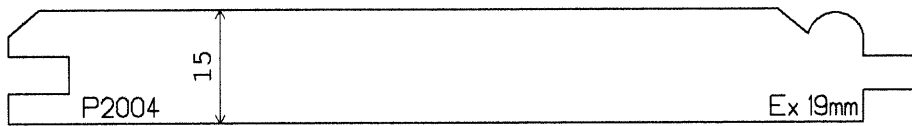
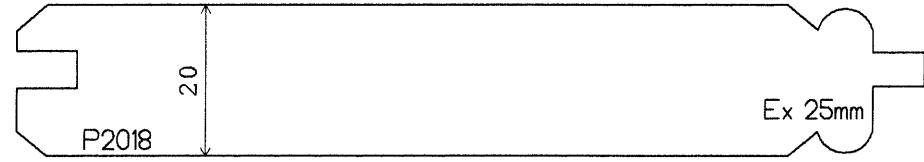
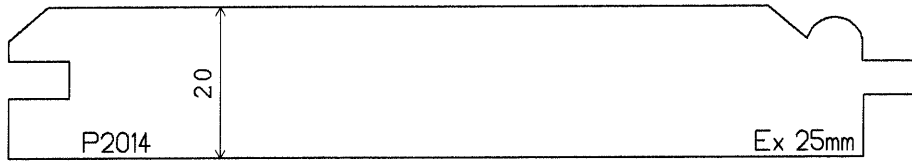
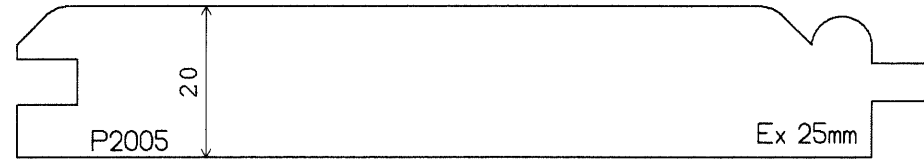
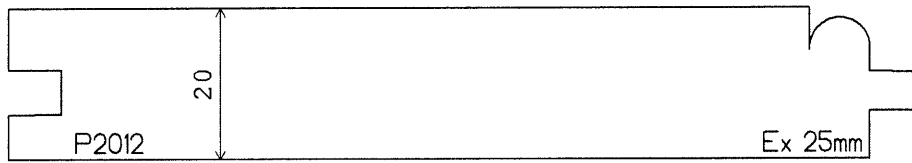

Hymor Timber Limited Catalogue of Standard Mouldings 2012

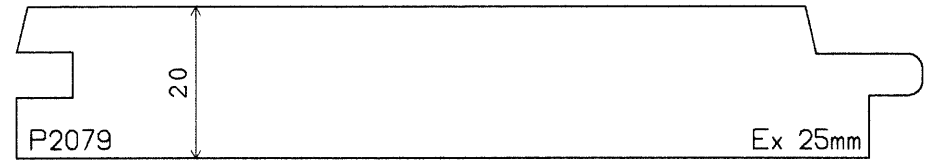
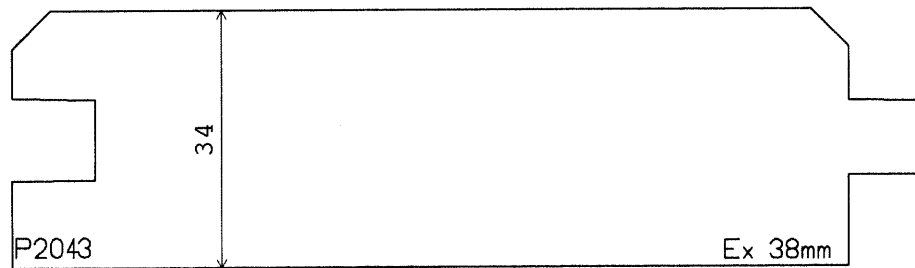
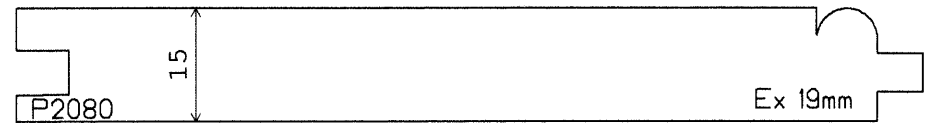
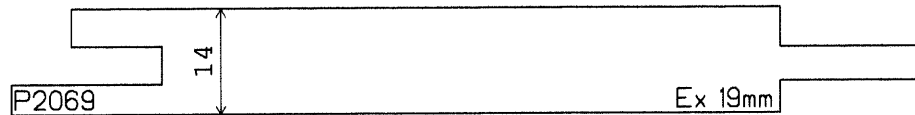
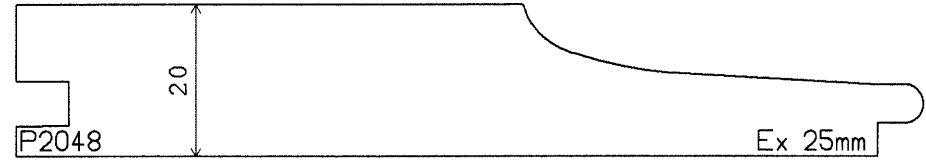
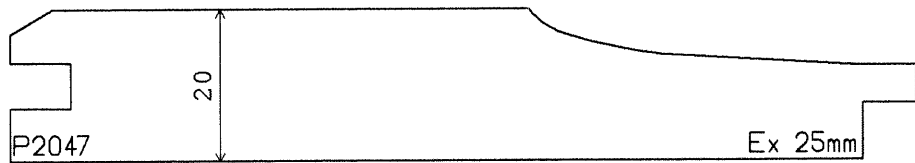
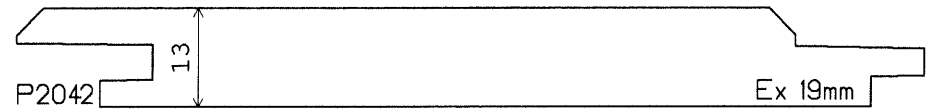
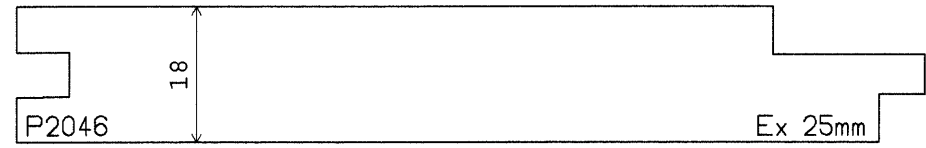
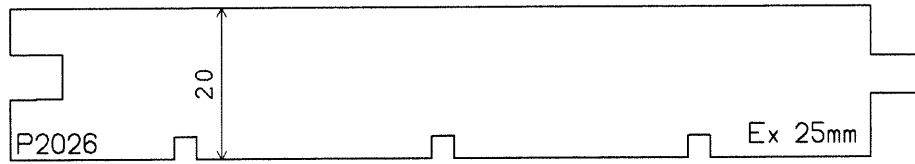

Hymor Timber Limited Catalogue of Standard Mouldings 2012

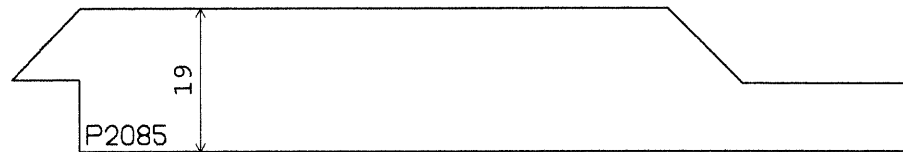
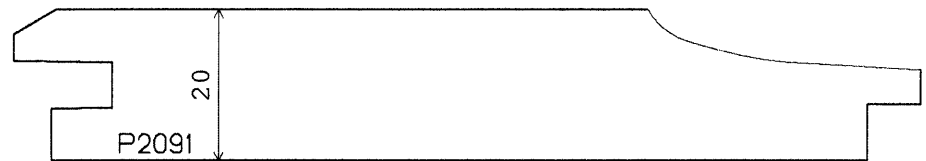
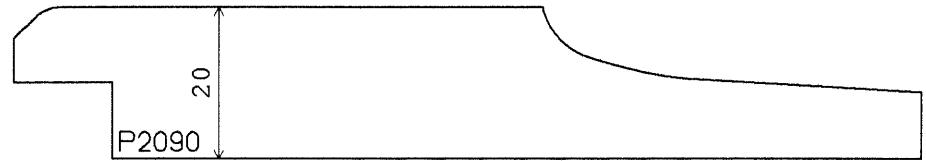
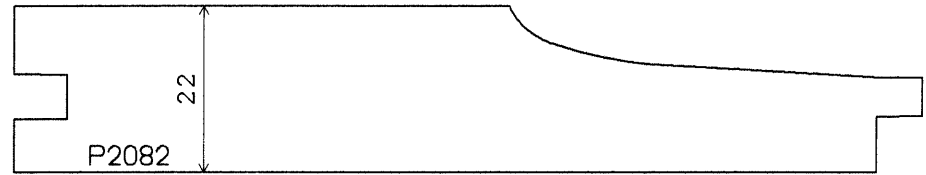
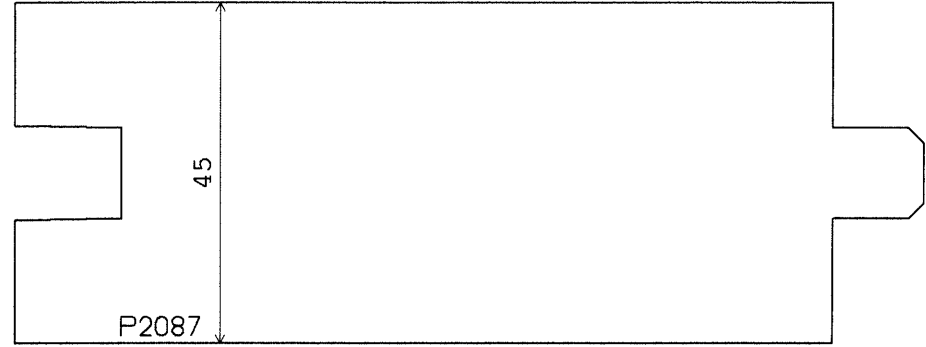
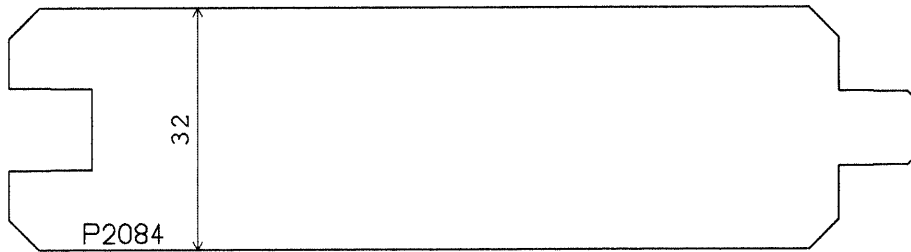
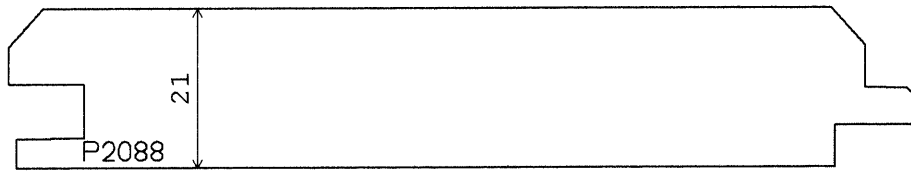
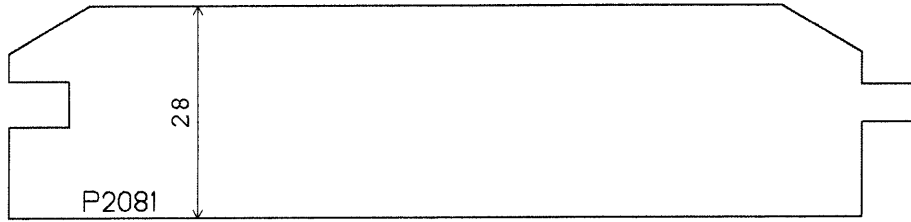
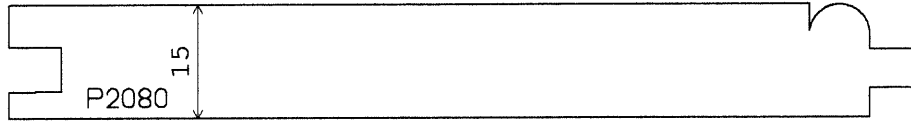

Hymor Timber Limited Catalogue of Standard Mouldings 2012

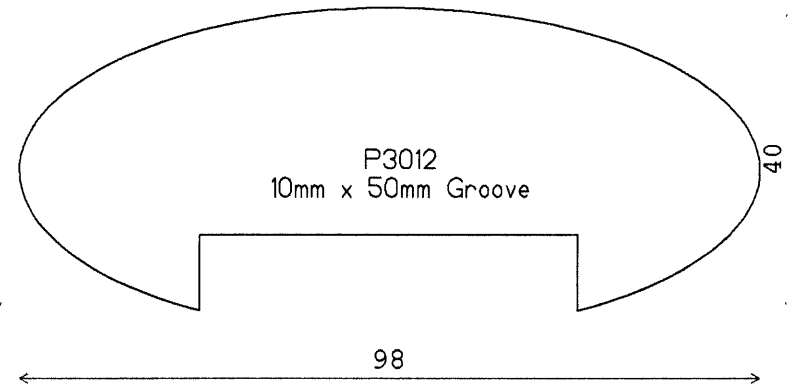
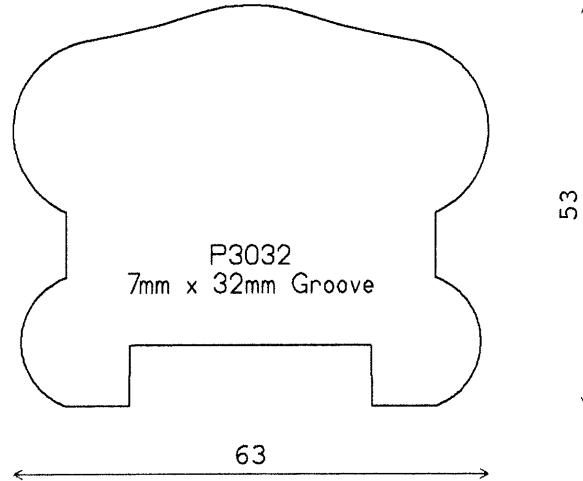
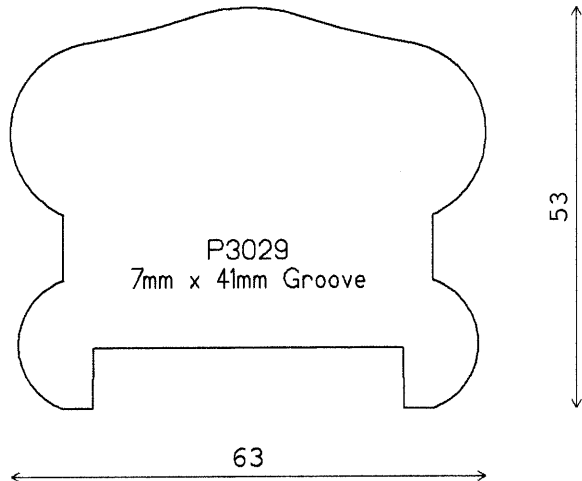
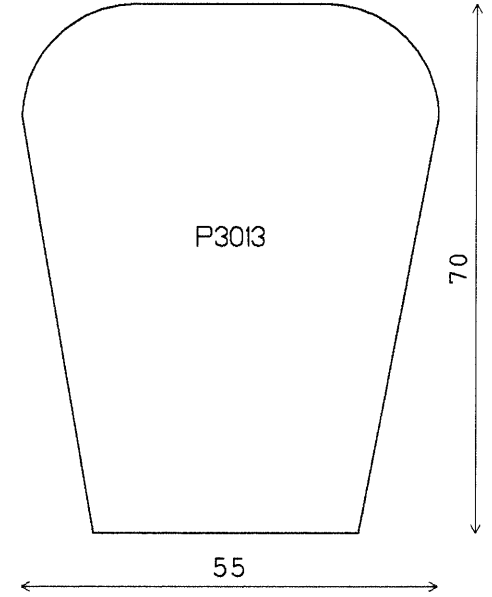
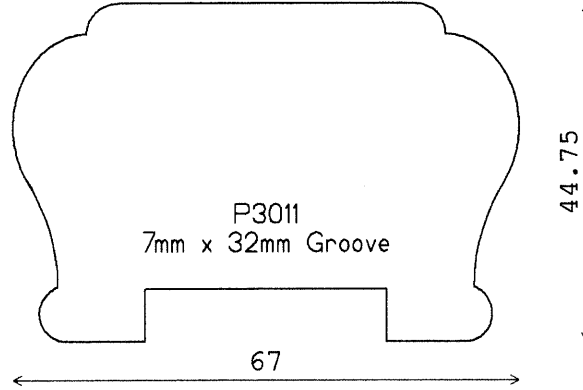
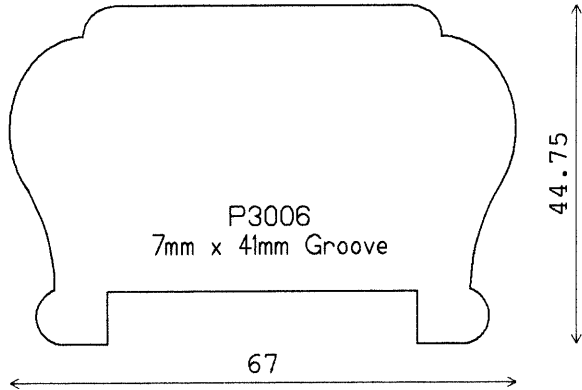
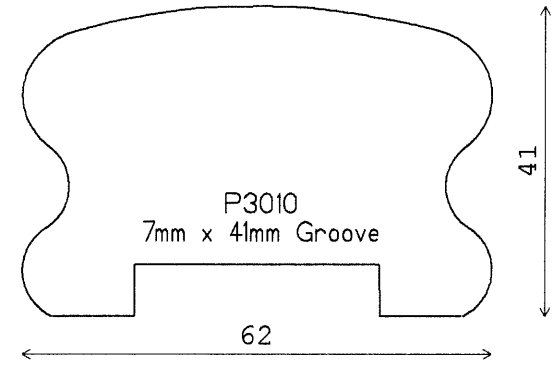
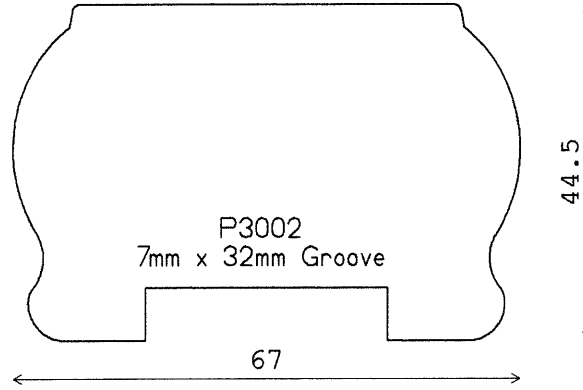
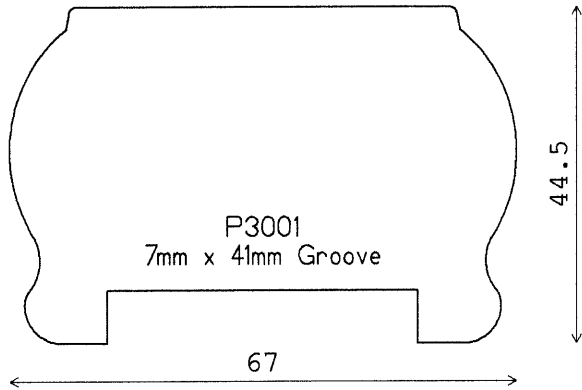

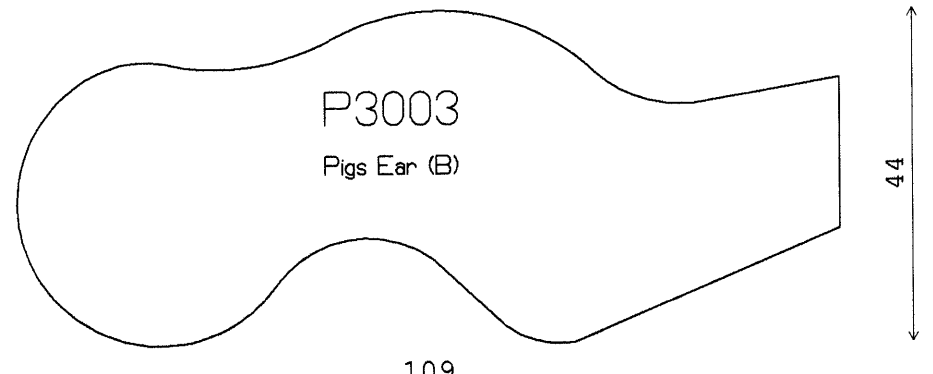
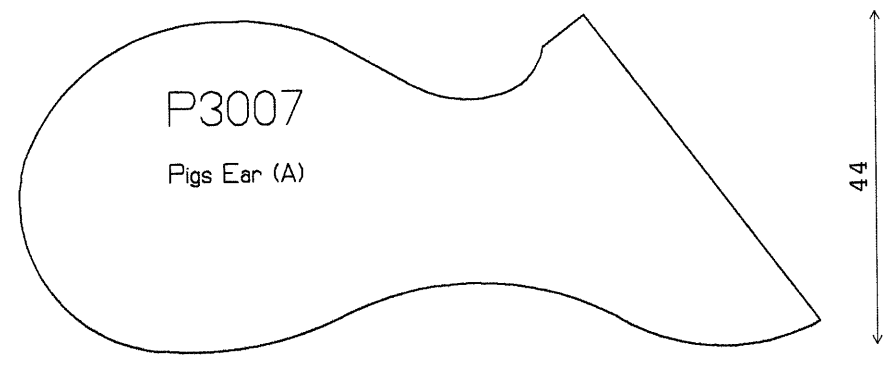
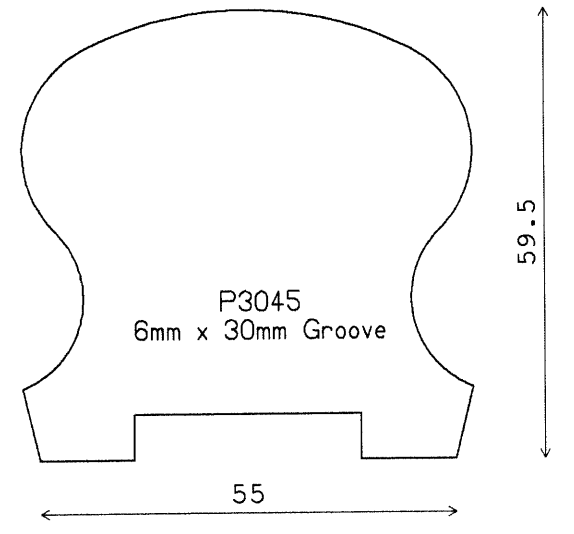
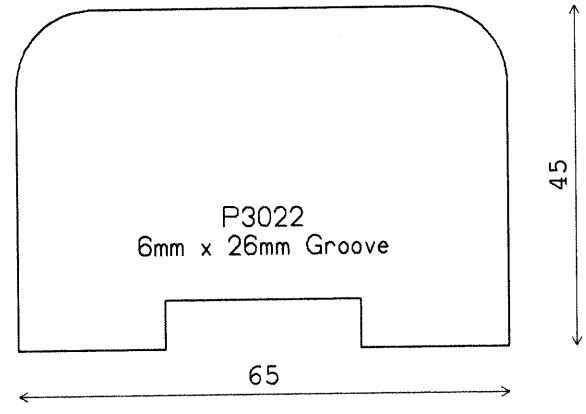
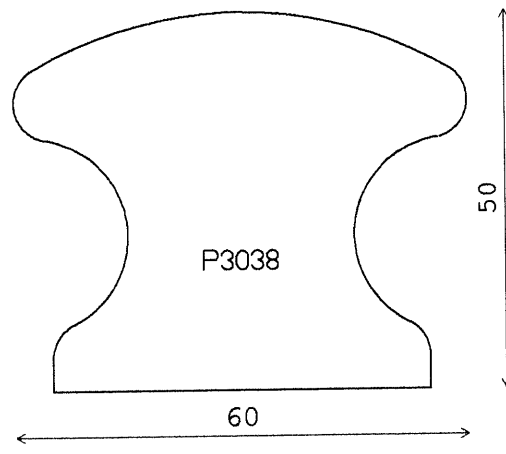
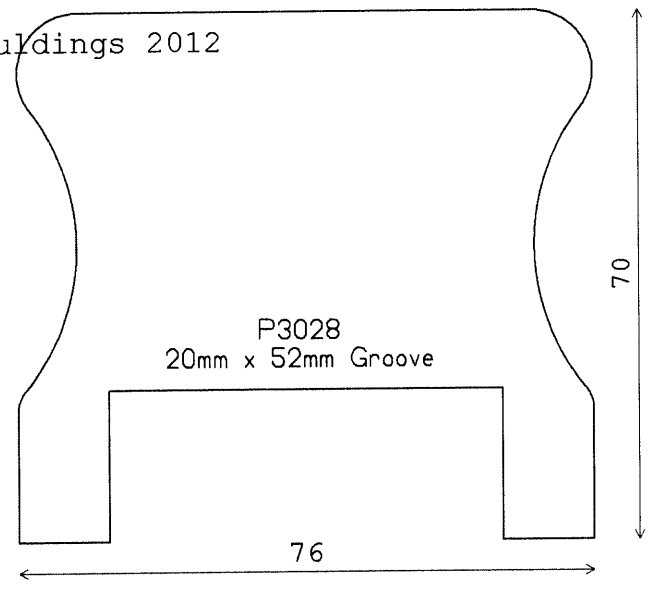
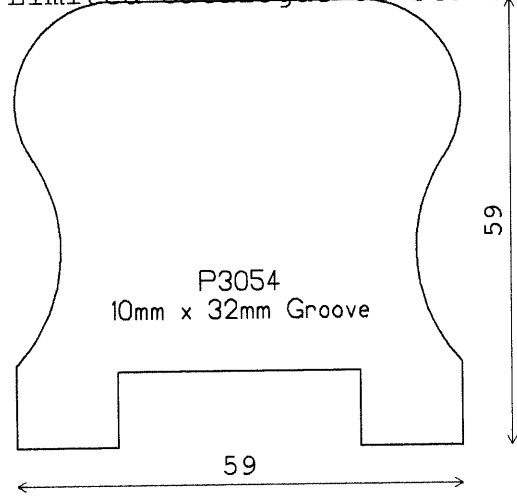
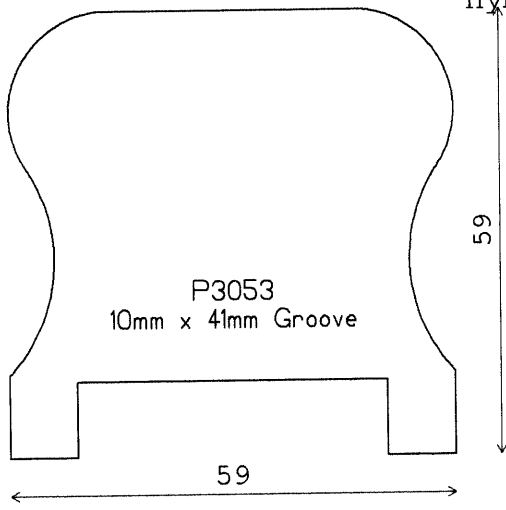

Hymor Timber Limited Catalogue of Standard Mouldings 2012

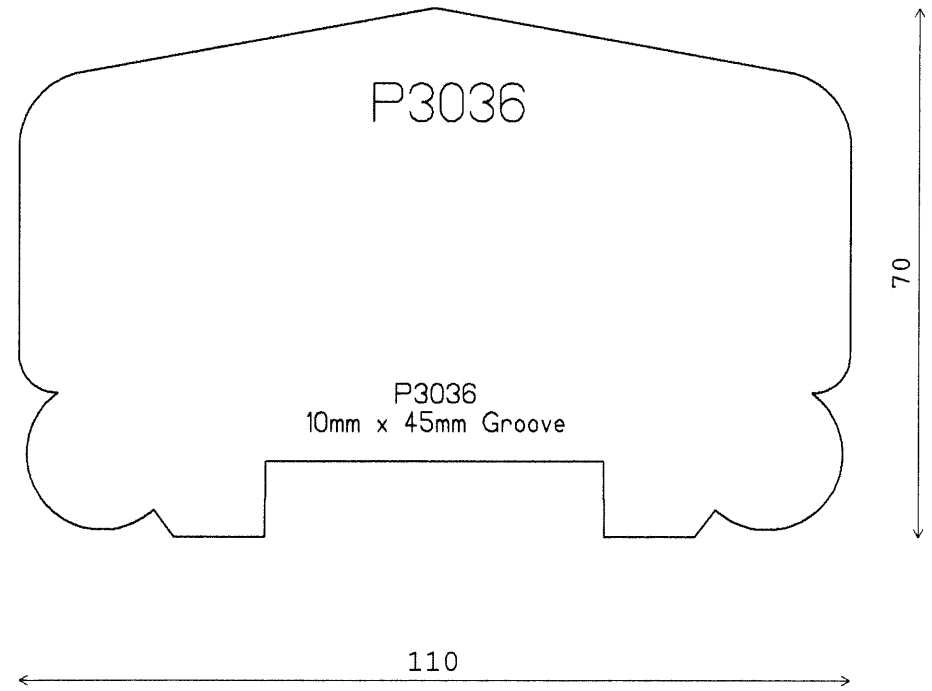
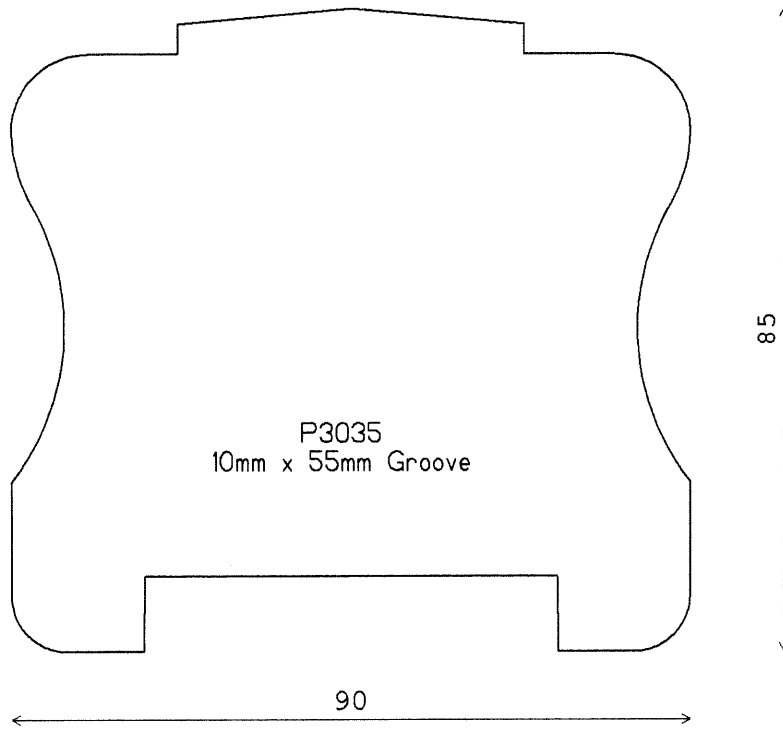
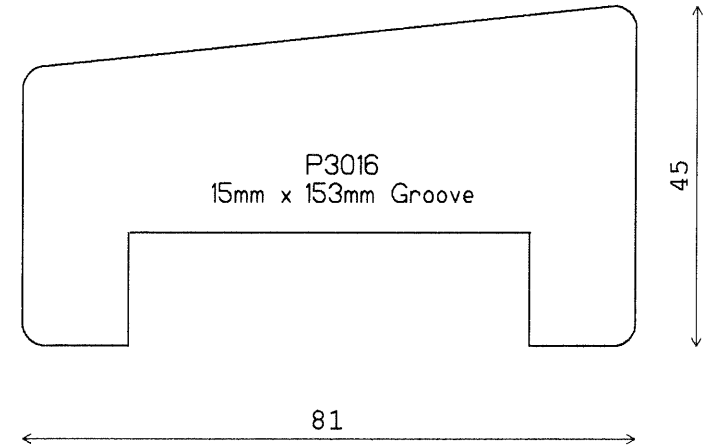
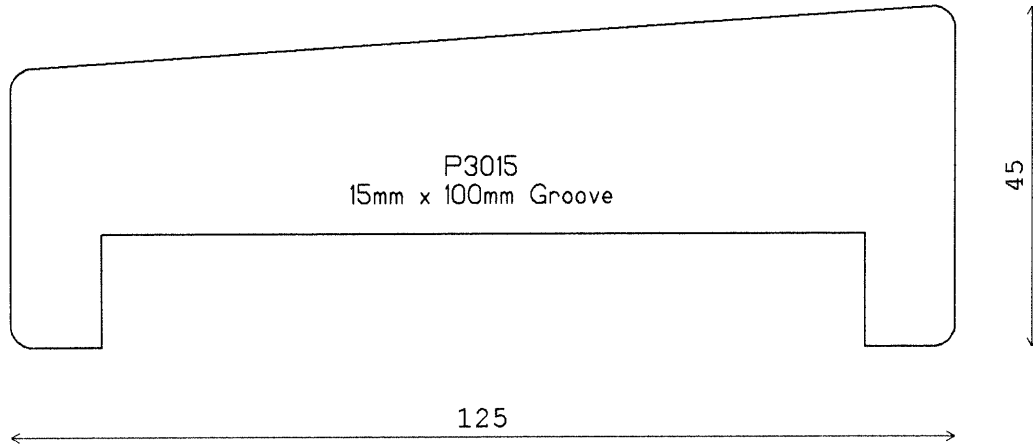

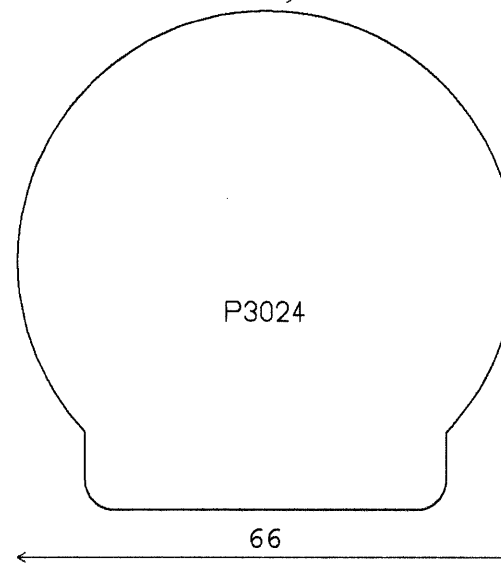
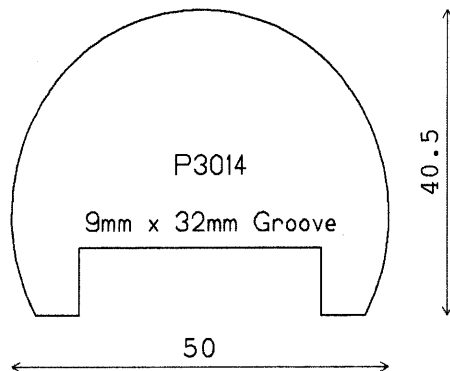
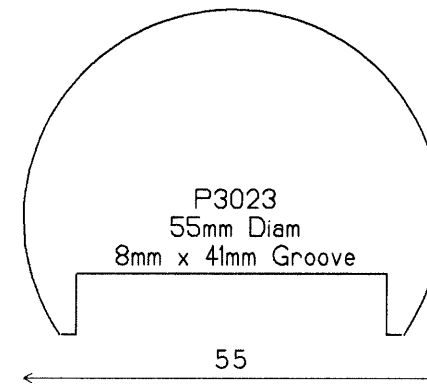
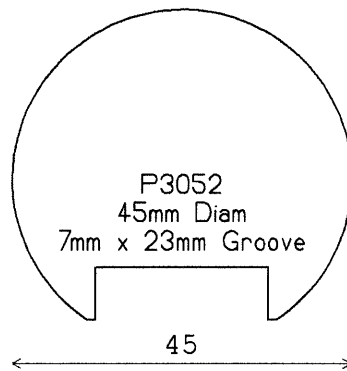
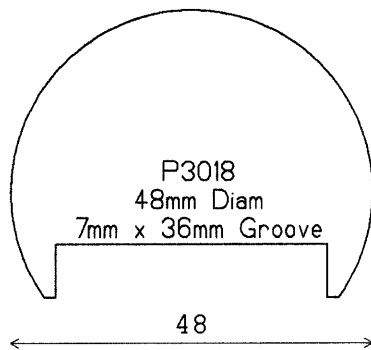
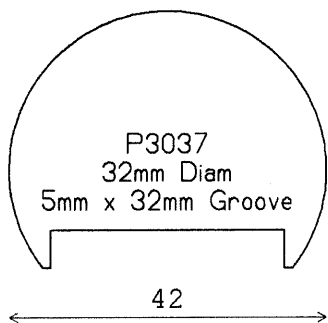
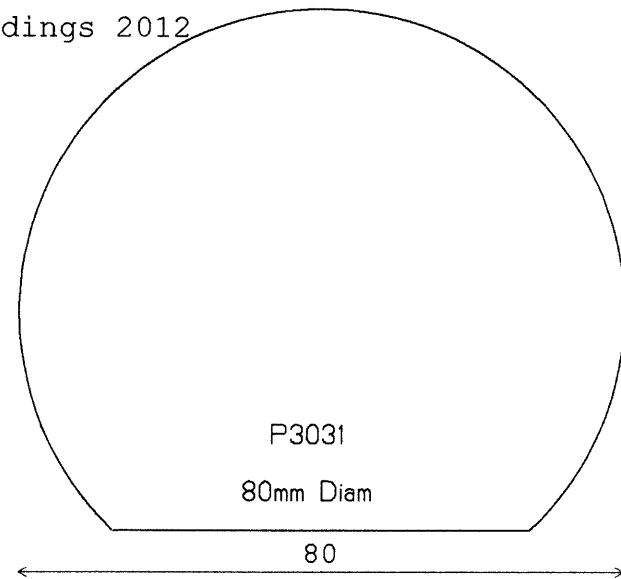
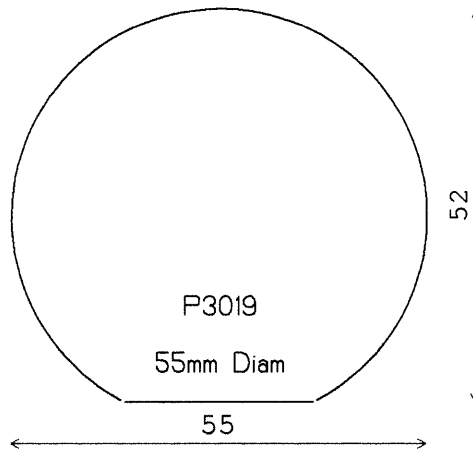
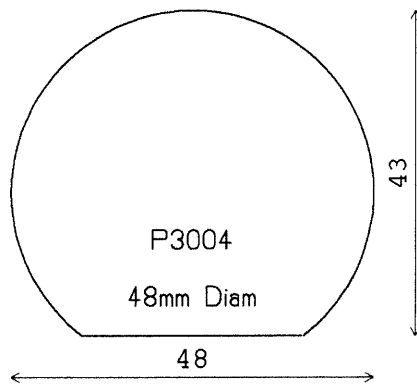
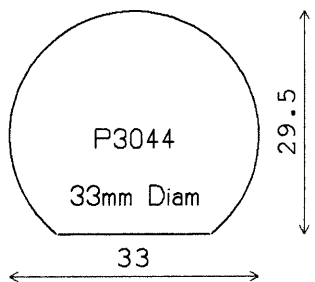

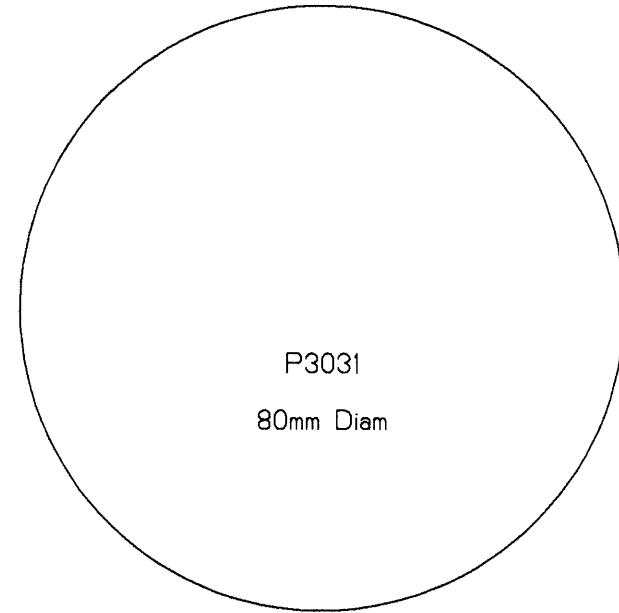
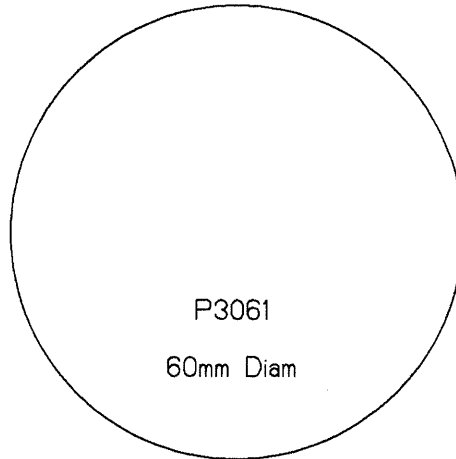
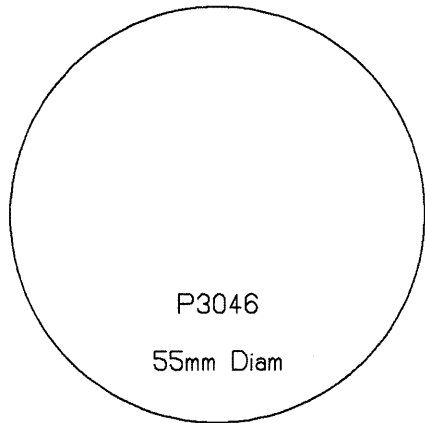
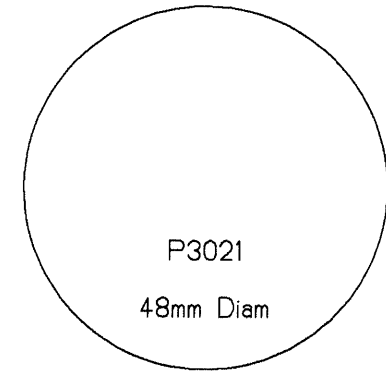
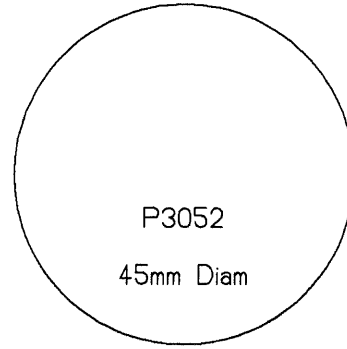
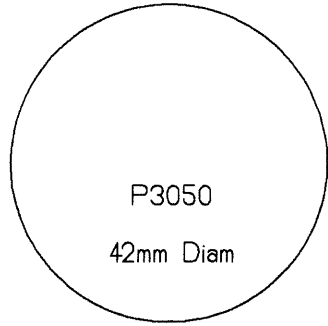
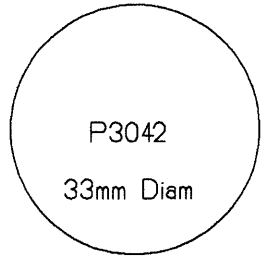

Hymor Timber Limited Catalogue of Standard Mouldings 2012

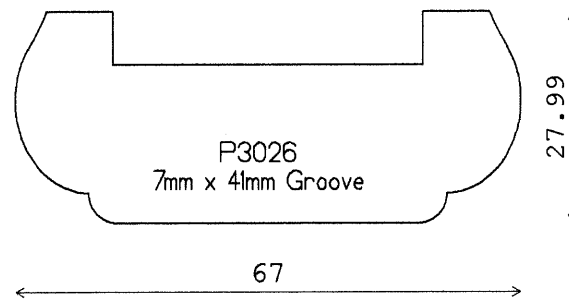
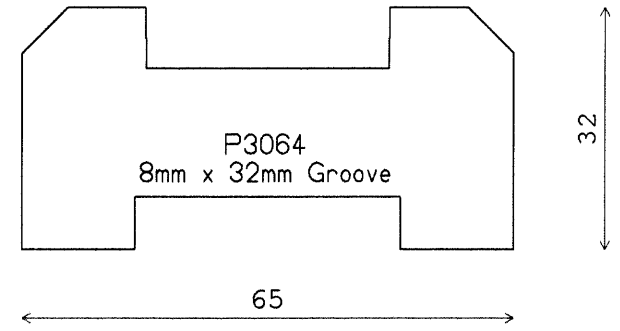
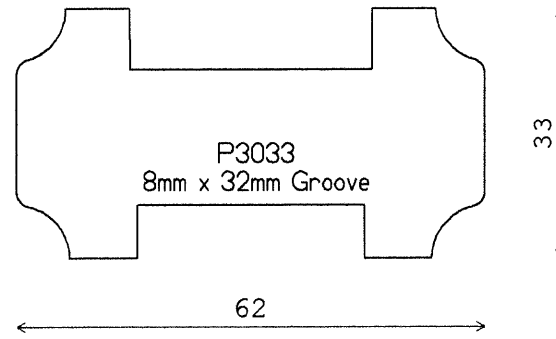
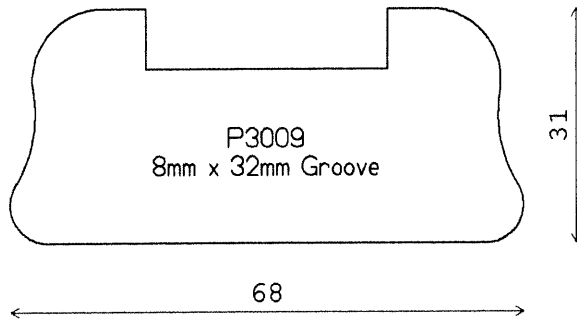
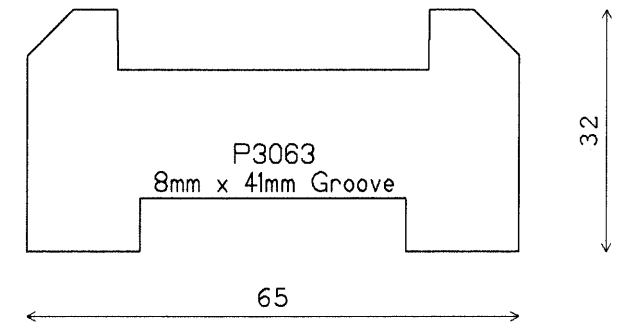
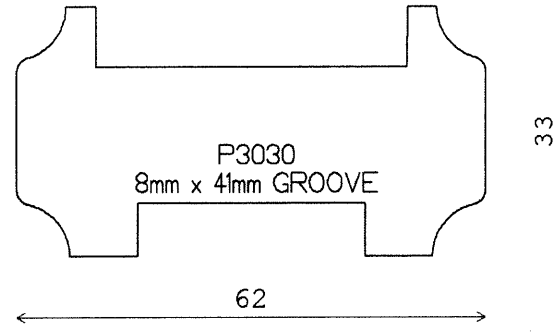
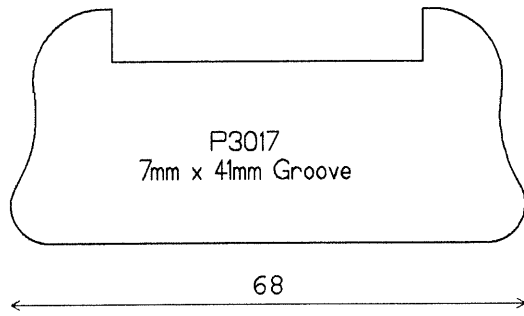

Hymor Timber Limited Catalogue of Standard Mouldings 2012

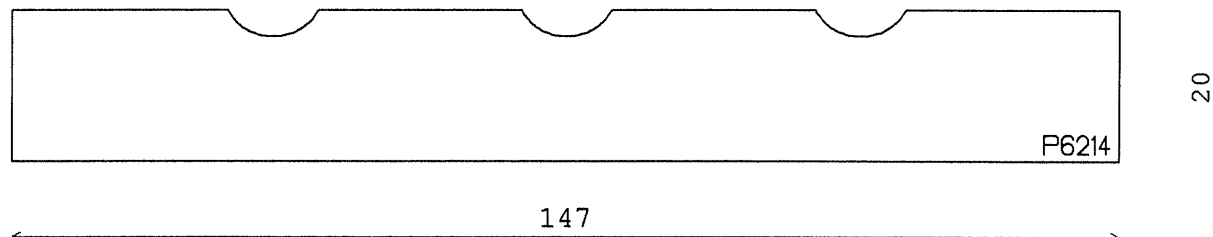
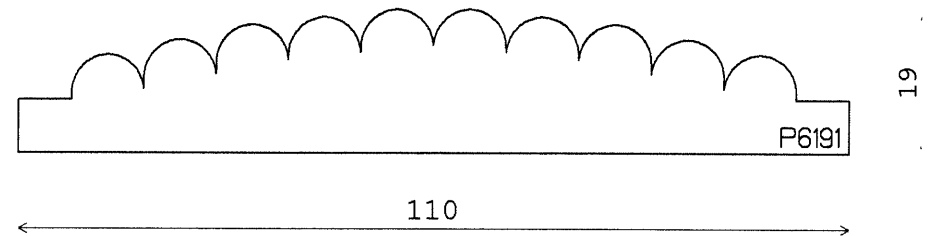
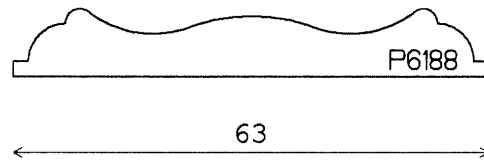
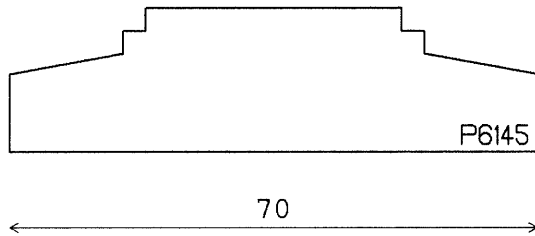
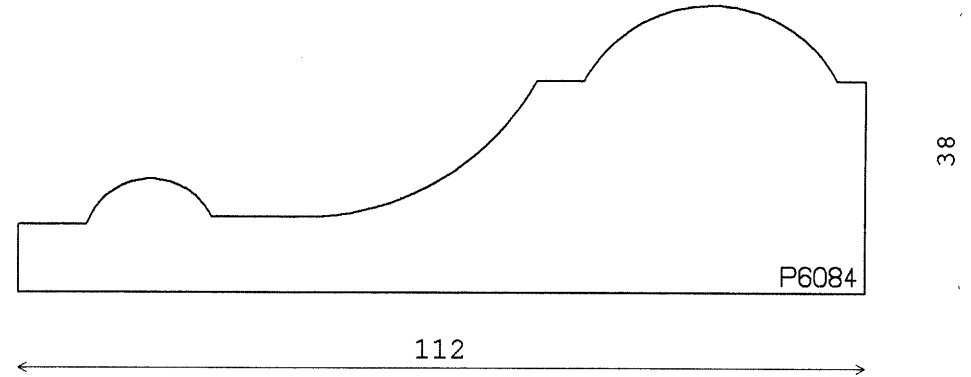
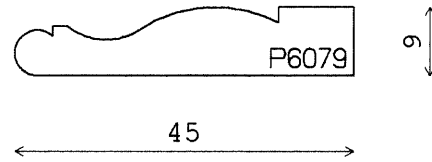
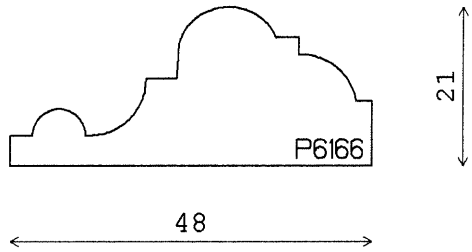
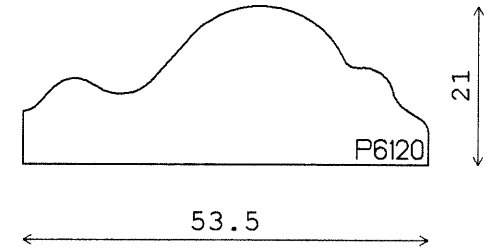
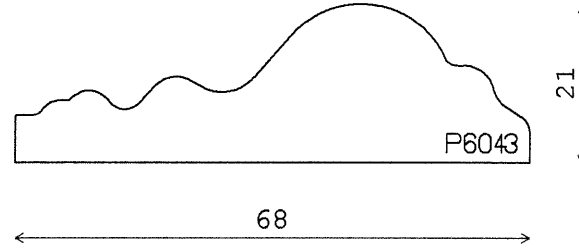
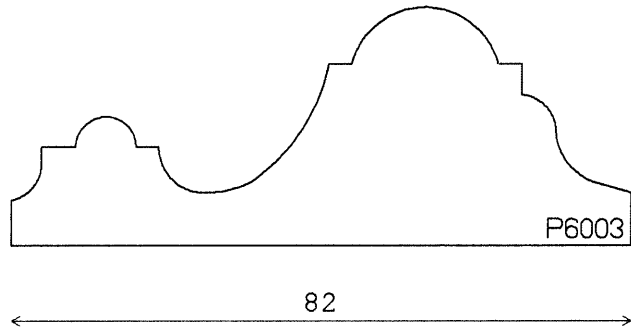

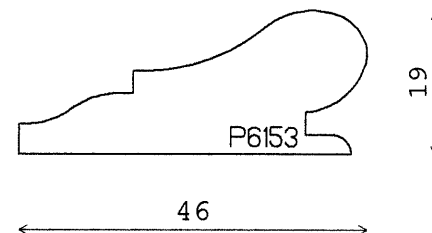
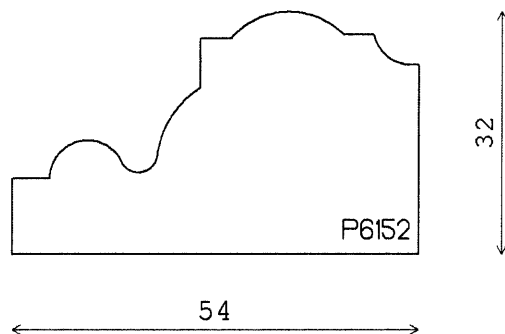
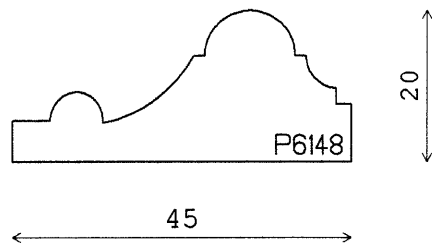
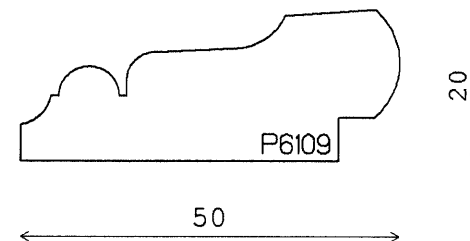
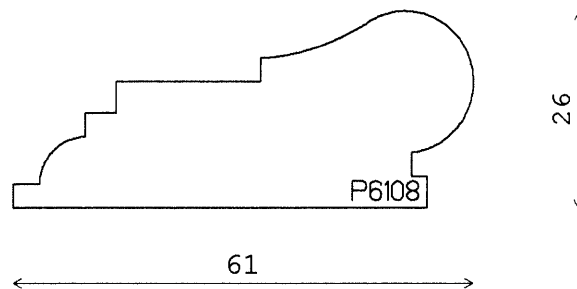
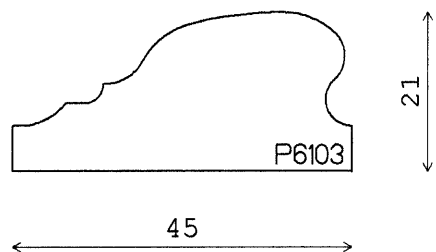
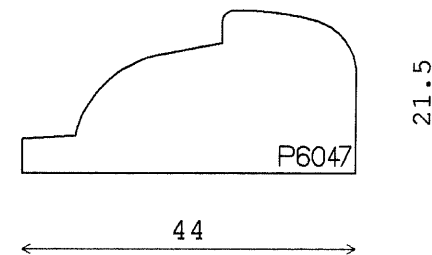
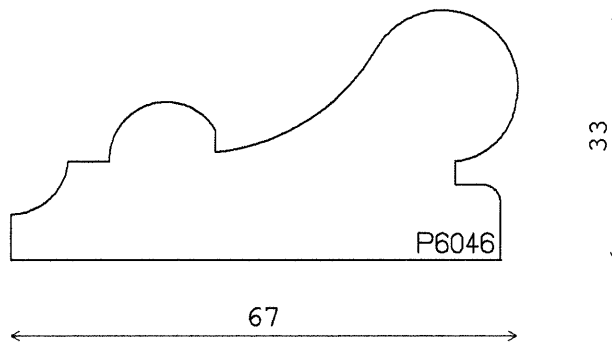
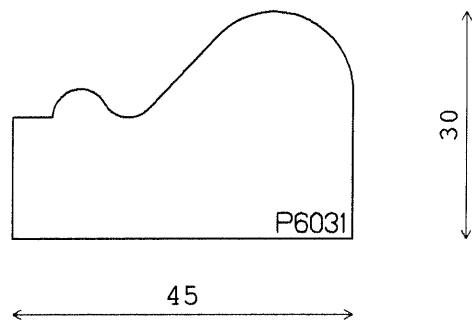
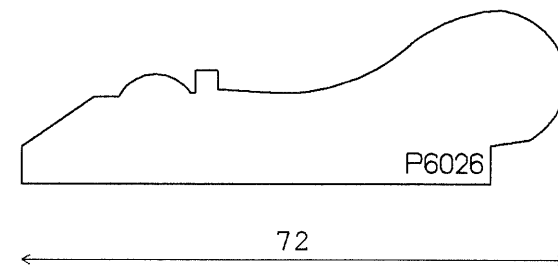
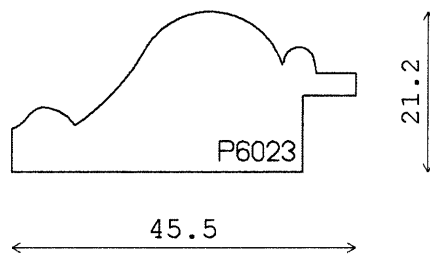
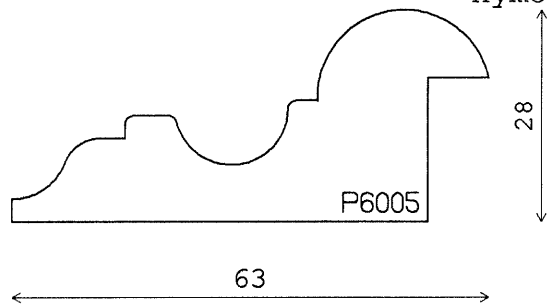

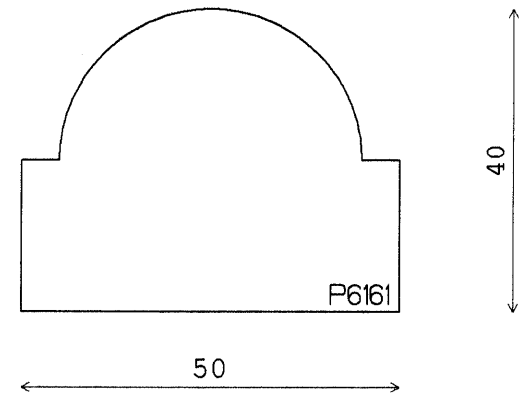
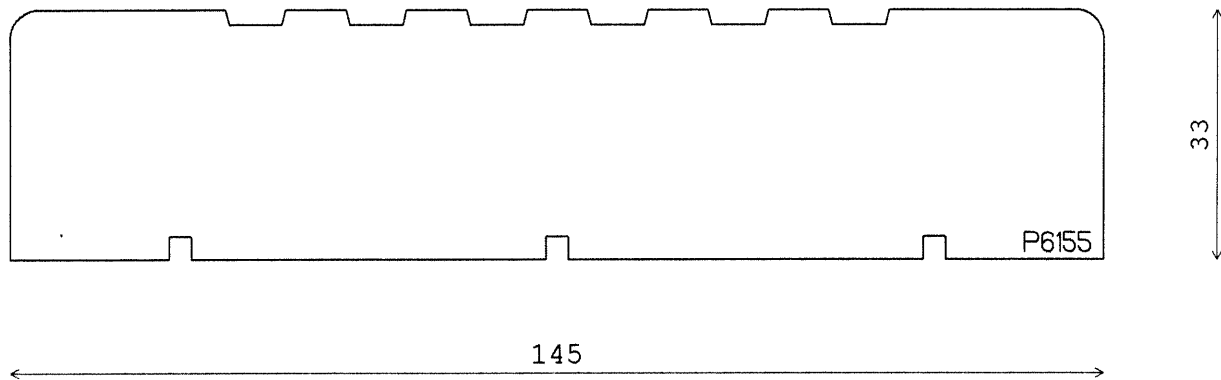
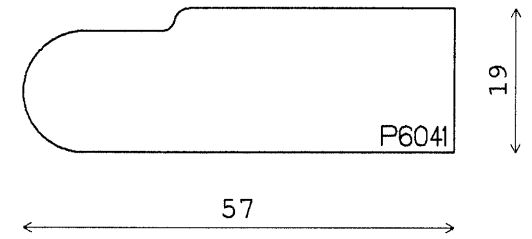
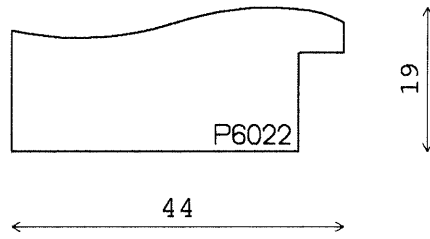
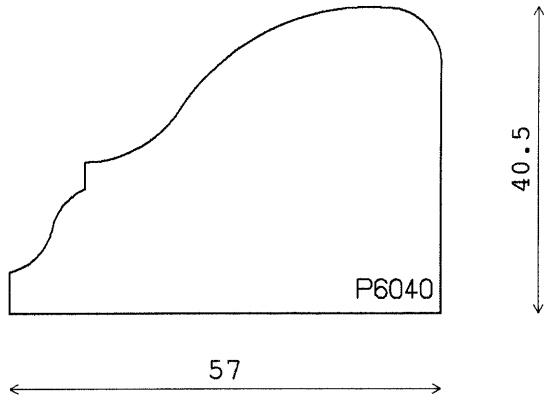
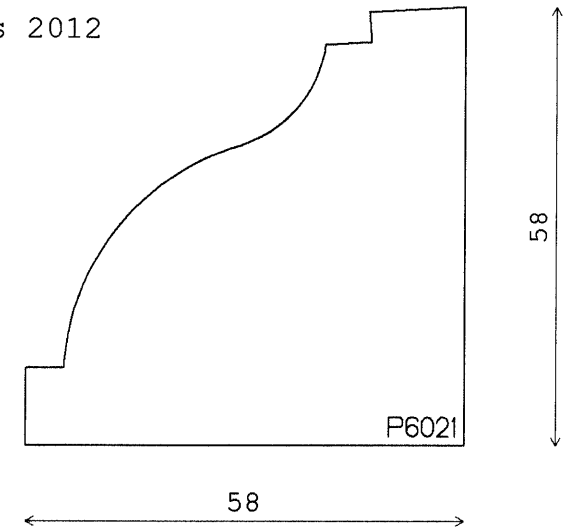
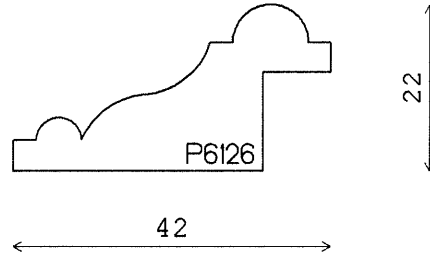
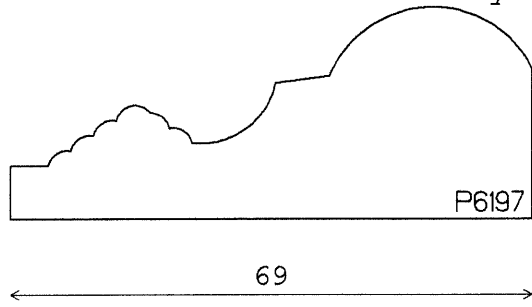

Hymor Timber Limited Catalogue of Standard Mouldings 2012

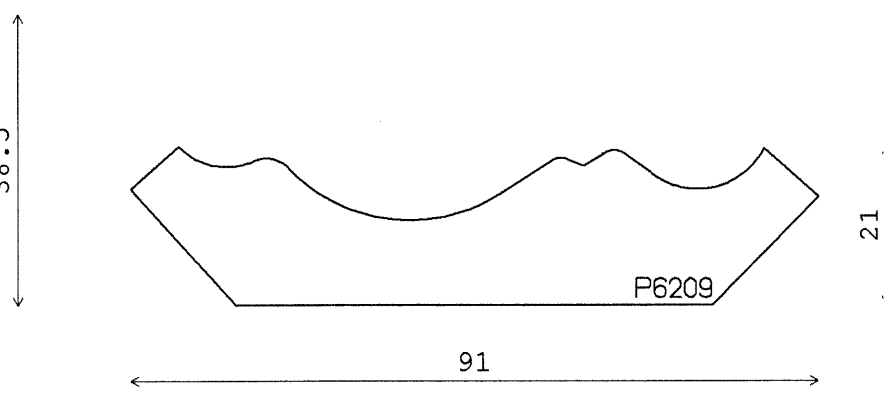
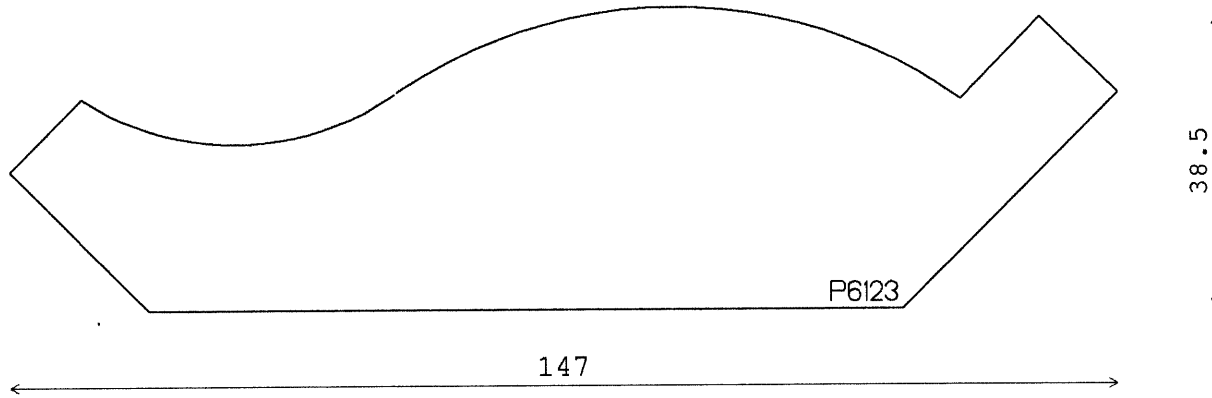
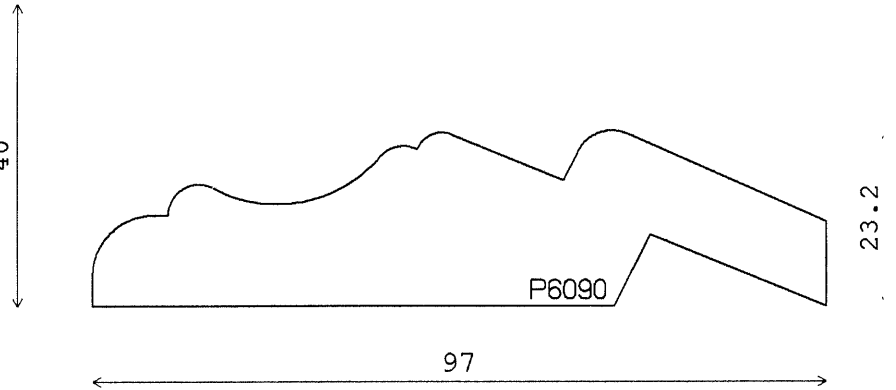
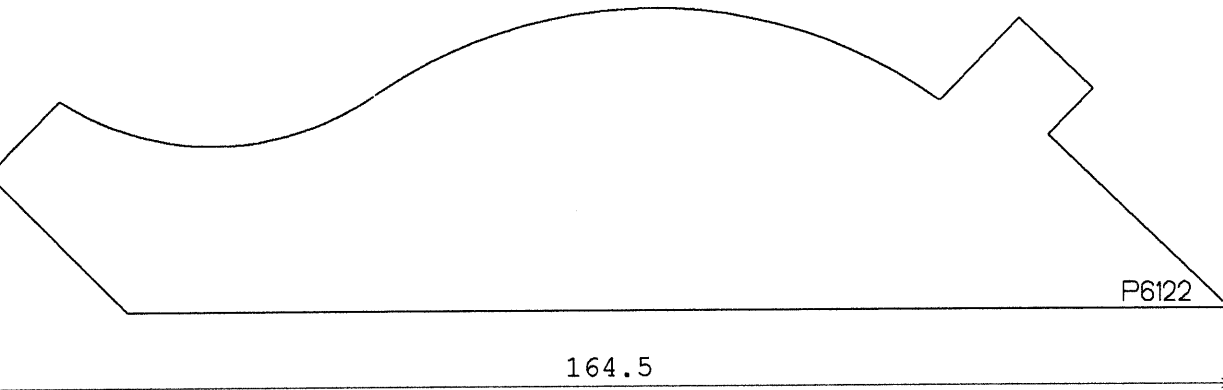
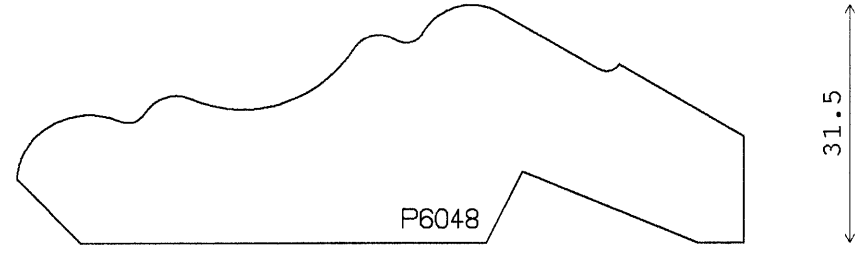
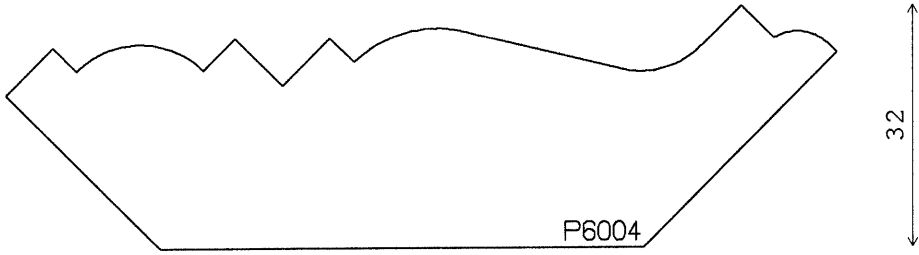

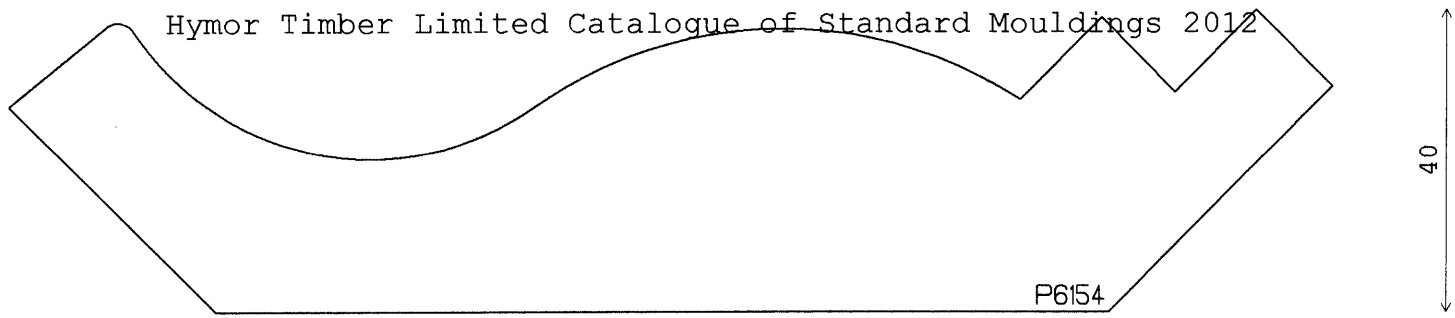

175

40

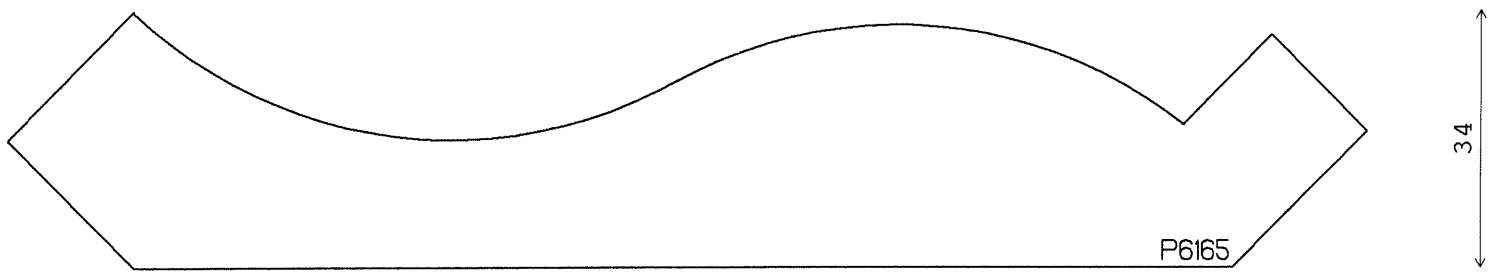

180

34

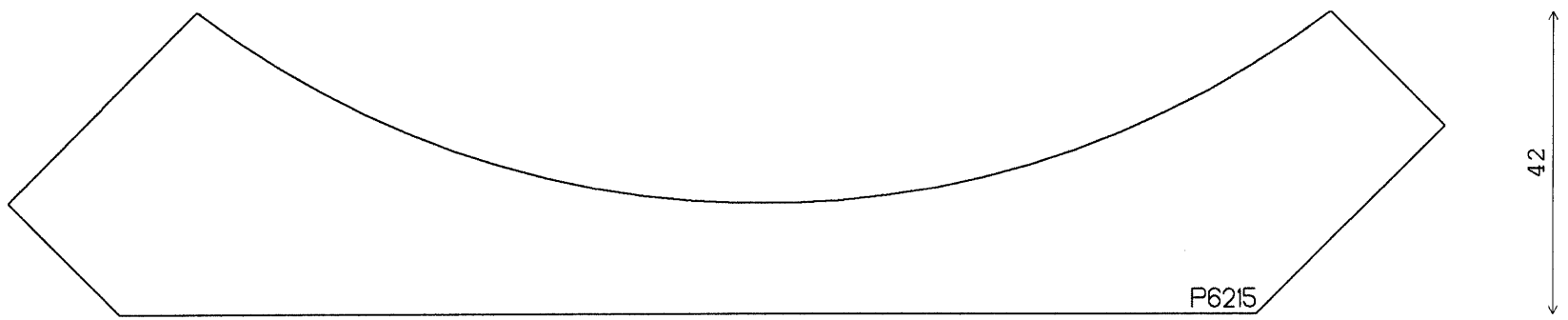

200

42

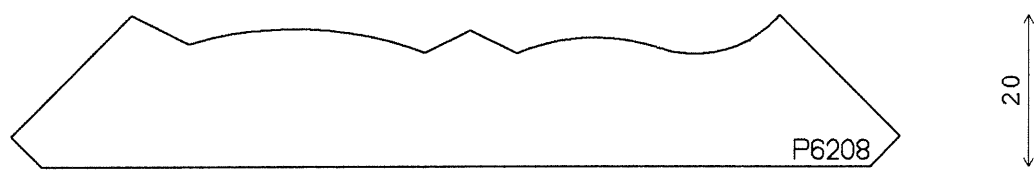

118

20

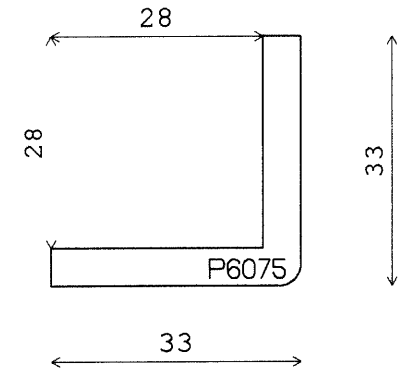
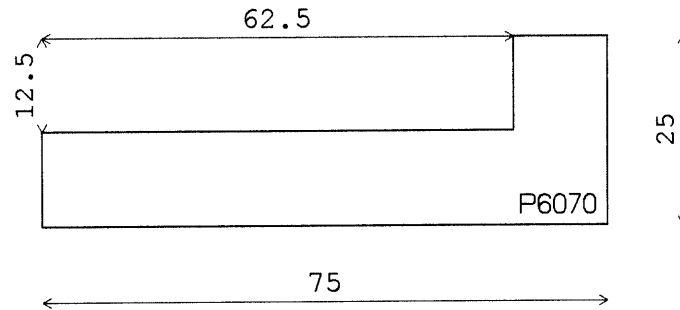
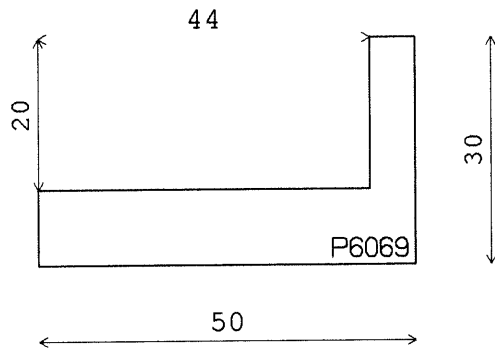
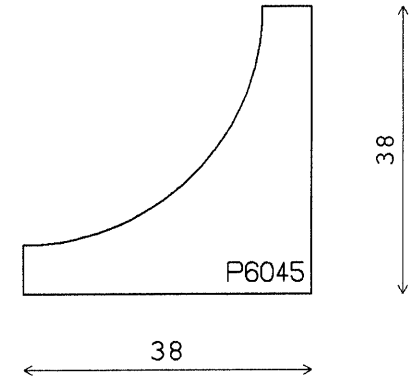
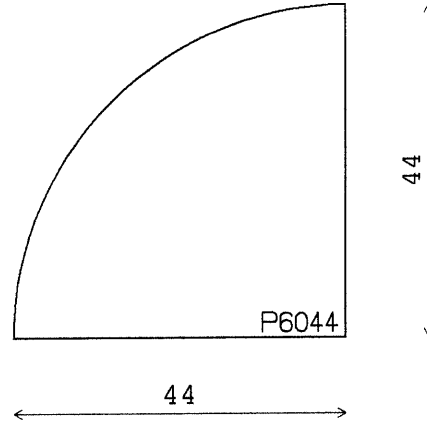
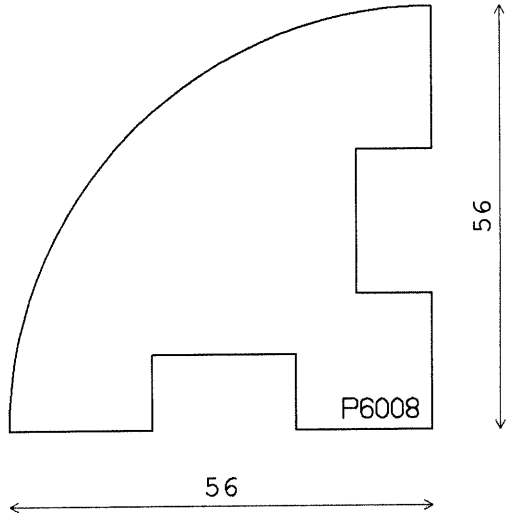

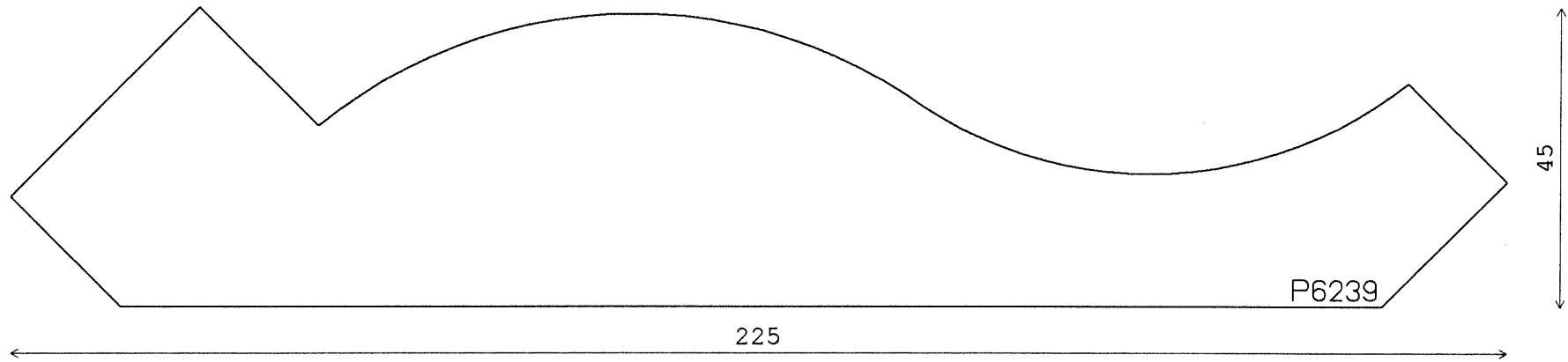
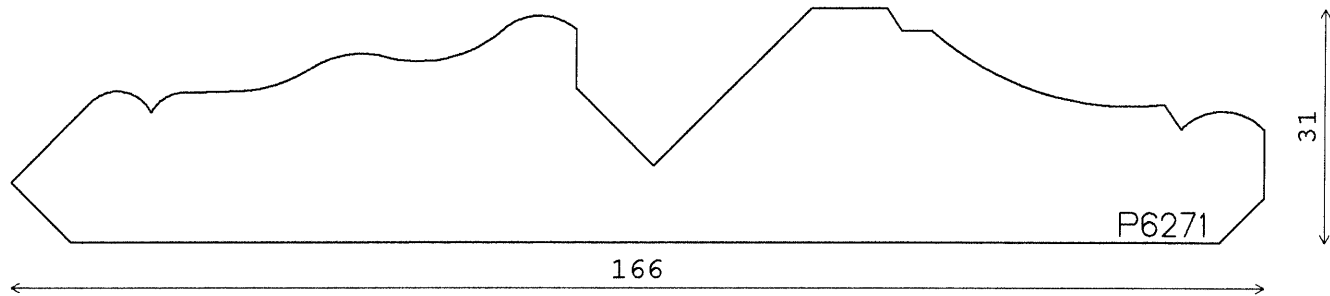
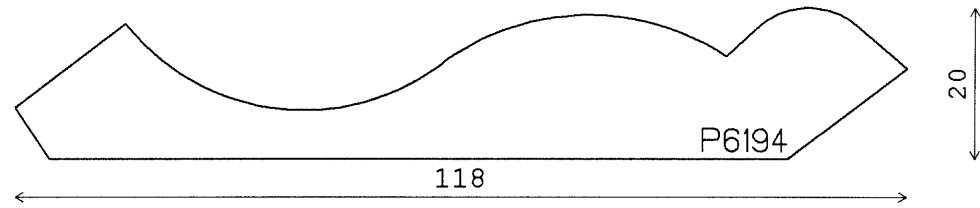

Hymor Timber Limited Catalogue of Standard Mouldings 2012

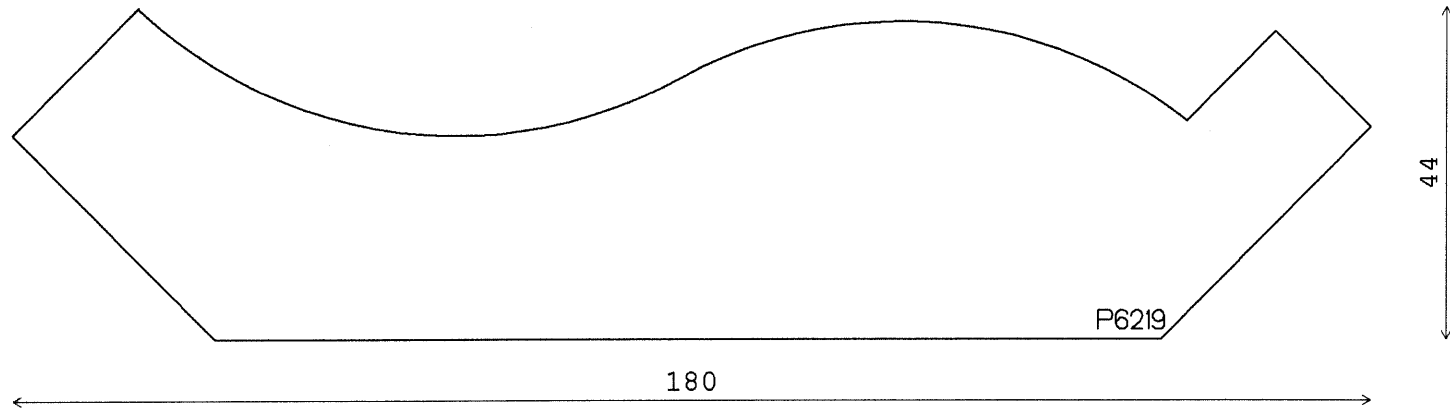
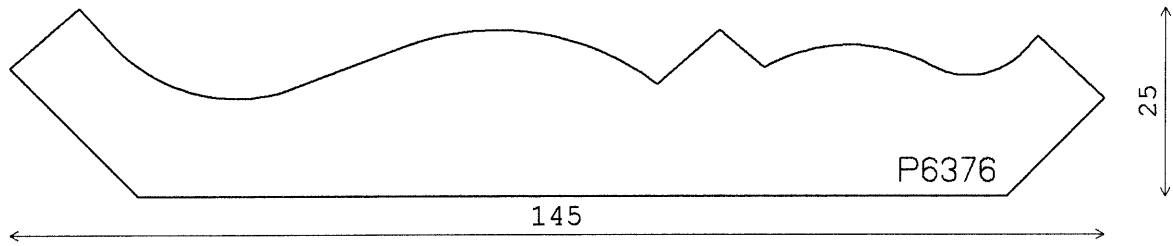
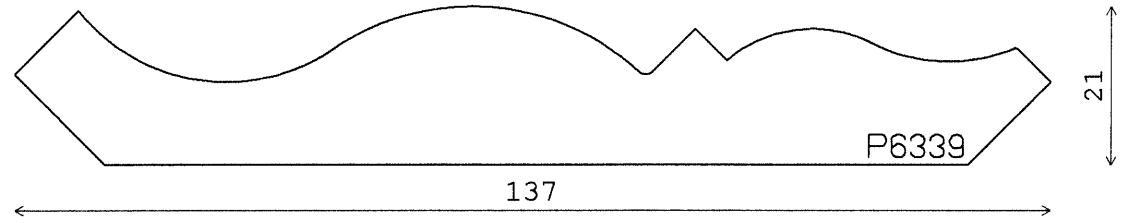
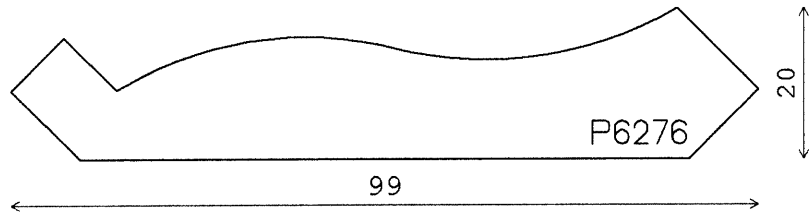

Hymor Timber Limited Catalogue of Standard Mouldings 2012

