

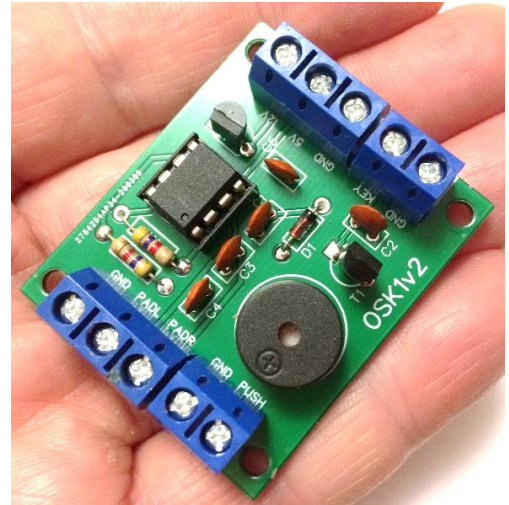

CW Memory Keyer Module OSK-1

The OSK-1 Keyer is a feature rich low cost memory Keyer, offering features that you would expect from keyer's much more expensive. The CW training mode is excellent and worth building the keyer just for this feature. The keyer is designed to work with transistorised rigs not Valve or Hybrids that use a negative keying voltage on the line.

The Keyer is built around a small but powerful microcontroller. The code for the chip is open source from Jan DK3LJ who developed the original program, later modified by Jack AL4SV and then further modified by Don WD9DMP who made some changes that polished Jacks code even more. The final product rivals professional keyer's costing many times the price.



This open-source code is now installed it onto a powerful Attiny85 chip, it fits on a small PCB and can be built in less than an hour.

Here is a list of its features.

Iambic A, B, Ultimatic modes

DAH Priority Mode

Paddle Swapping

Side tone Toggle

Adjustable Side tone Pitch

ATU Tune Feature (20 Sec Key Down) with one touch cancel

TX Keying Toggle (Side tone only for practice)

TX Level Inverter mode

WPM Speed feedback

4 x 100 char Memory's

Automatic Beacon (for FOX hunts etc.)

Callsign CW Trainer (Sends random callsign, users send back)

For more details of each feature read the user guide at the end of this document.



KANGA PRODUCTS

Electronic Kits For The Radio Amateur

Let me show you the circuit for the keyer.

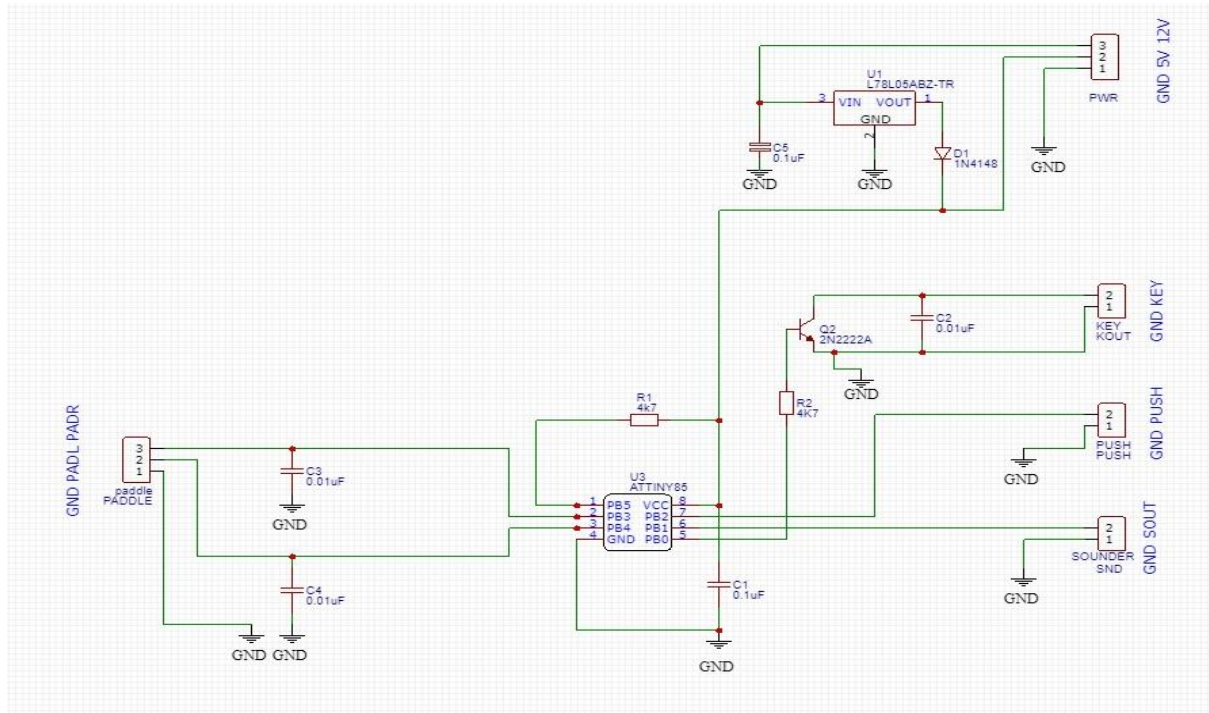

Parts List

Programmed Attiny85 DIP8

DIP8 IC socket

QSK-1v2 PCB

3 x 3k9 resistor ¼ watt

3 x 10nF capacitor (may be marked 103)

2 x 100nF capacitor (may be marked 104)

2N2222A transistor

78L05 5v regulator

1N4148 diode

Piezo Sounder

Push Button

2 x 2 way block

2 x 3 way block



This can be built into any homebrew radio or boxed for use with a main station rig etc.

The circuit board.

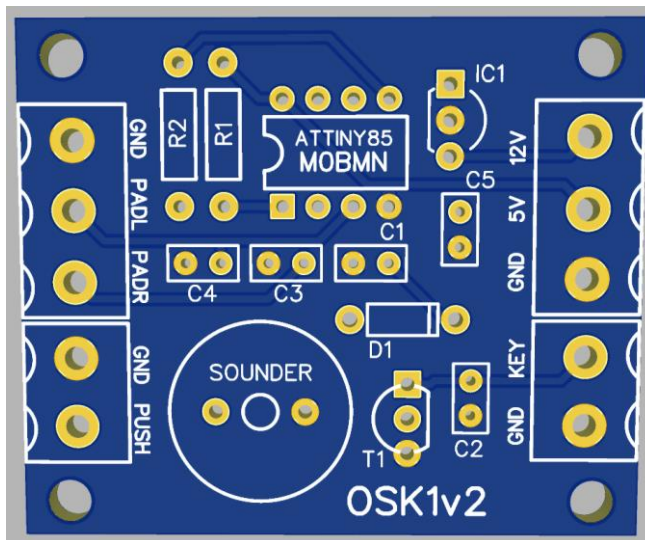

The PCB is Size 45 x 38mm

The boards both include a small dc regulator so you have an option in how to power the keyer.

You can power the module from just 2 AA or AAA batteries (like I have) the chip is happy to work down to 2.7 volts may be 2.6v at a push so two fresh AAA/AA cells will power this for many months. The current consumption measured in use is just under 1mA and after 60 sec's of no activity the module goes into sleep mode and only draws a couple of

microamps. I do not feel it's worthwhile fitting an on/off switch due to such low standby current but that's up to you. If you do power this keyer from such a battery pack then use the 5V power connection, this can accept voltages up to 5.5V max. Note **more will destroy** the keyer. The 12V input point will accept voltages from around 7 to 15v (a 9V battery will work well on this point) so you can power the modules from the main stations 13.8v DC supply if you wish.

If using the higher voltage input from a battery I would use a switch as the regulator draws additional current at all times.

OK so let's make a start building the keyer.

If you are new to kit building tick each part off in these instructions when you have it fitted.



Step 1 Resistors

Both resistors are the same value so you can't get them mixed up, they can be fitted either way around.

First fit R1 (3k9) #

Next Fit R2 (3k9) #

Step 2 Capacitors

There are 5 capacitor's and 2 different values use, make sure you fit the right one in the right place, like the resistors they can be fitted either way around. One tip, if you can fit them so the value marking can be seen when the board is completed in case of any errors in placement.

C1 0.1uF (Marked 104) #

C2 0.01uF (Marked 103) #

C3 0.01uF (Marked 103) #

C4 0.01uF (Marked 103) #

C5 0.1uF (Marked 104) #

Step 3 Diode

The diode is there to make sure that the 5v input does not back feed into the voltage regulator and also will drop the voltage to below 5v from the regulator output, the chip is only rated up to 5.5v so this gives us a little more head room. Unlike the resistors and capacitor's, the diode MUST be fitted the correct way round, if you look at the diode you will see one end has a black band on the glass, this is the cathode side, on the PCB you will find position D1 which is our diode, the symbol shows a extra white line at one end (near R1) this is the end that MUST have the black band on the diode pointing towards

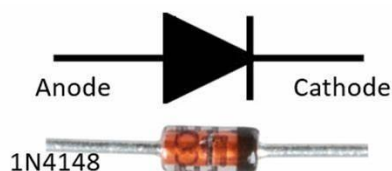

D1 1N4148 #



KANGA PRODUCTS

Electronic Kits For The Radio Amateur

Step 4 Transistor and voltage regulator

This is the most difficult part of the project, only because the pins are very close on the PCB and so it would be easy to make solder bridges between pins, take great care when fitting these parts. The transistor and regulator again can only be fitted one way. If you look at the body of these devices you will see one side is flat, this has the part number printed on it. This flat side MUST be fitted towards the Flat line indicated in position Q1 and U1. Now be extra careful that you do not fit the 5V regulator in the wrong position. Fit the transistor in Q1. Use a magnifying glass if you must to make sure that the part you fit say's 2N2222 (or 2N2222A) on the flat side and not 78L05 (that's the voltage regulator). Once that's fitted fit the regulator in position U2, make sure the flat side is towards the flat line on the PCB screening. See the pictures below to help identify the parts.



Image of 2N2222
(2N2222A may be supplied)

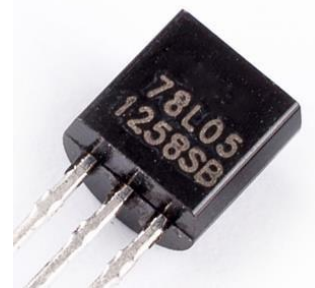

Image of 78L05 Don't get them

mixed up!

Q1/T1 2N2222 #

U2/IC1 78L05 #

Stage 5 The 'brain' the ATTINY85

This 8 legged little chip is the brain of the keyer, for its size it is very powerful. I had computers back in the 1970's that sat on the desk that did not have the power and speed of this chip, don't let its size fool you. This is also the most expensive part of the keyer. I have provided a socket for the chip that can be fitted onto the board first, this way the chip can be removed if there is any problem with the rest of the board and then reused, If soldered in place directly it can be very difficult to remove without damage.

This must be fitted the right way on the board, if you look at the top of the chip you will see a small dot in one of the corners.



KANGA PRODUCTS

Electronic Kits For The Radio Amateur



the chip.

8 pin Socket #

Atiny85 #

This tells us which pin is Pin 1

On the circuit board in position U1 you will see the outline of the chip and a small dot next to one of the corner pins, this is pin 1 the dot on the chip must be aligned with the dot on the board.

Now you know which way the chip needs to be fitted fit the socket first and then

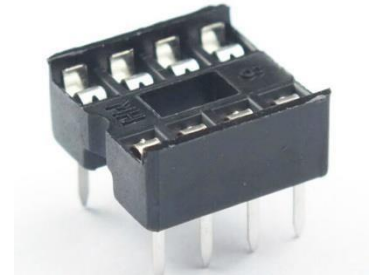

That's the module built, now just to wire and test it.

You have a choice now, the sounder is normally fitted directly on the PCB but if you want it too can be fitted remotely so that it can be heard better. I would just fit it to the board but

make sure you not the polarity, it will be marked on top of the sounder with a '+' sign in a circle. Your sounder may look different than the one in the picture.

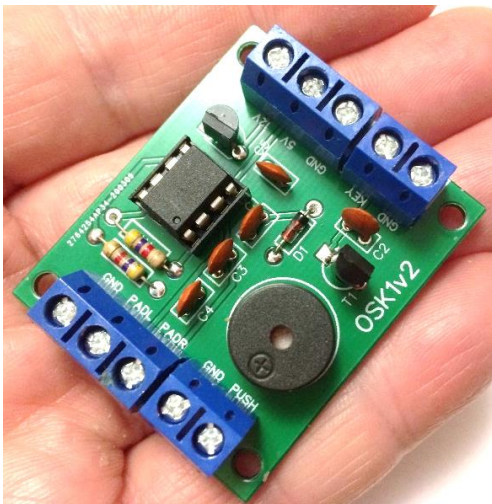

The wiring is straight forward as the pins are labelled by the blocks on the board.

The mode control is connected to the GND/PUSH block. The output to your rig connects to the terminal block GND/KEY and the paddle connects to the 3 way block GND/PADL/PADR and of course power to the power block.

The Keyer has many features, it's VERY important to read ALL the instructions below before you try to use it, many of the options will be set once and forgotten, for example positive or negative keying output

One feature I really like is the CW training mode, at the selected keyer speed it will generate a callsign (not a real callsign but follows the typical format) and sends it to the user, the user sends back the callsign, if right you get a 'R' and a new callsign is sent. If you get it wrong you get the error signal (.....) and it resends the same callsign again until you get it right. It a nice extra feature that makes practice more fun. BTW if you turn Farnsworth mode on it will use that in this mode which is a big help if learning the code.



KANGA PRODUCTS

Electronic Kits For The Radio Amateur

Keyer Instructions

Version: 0.87 Usage (WD9DMP Fixes and Enhancements)

After reset in default mode, the keyer plays "73" to verify that the Code and EEPROM data are programmed correctly. The circuit operates as a regular IAMBIC keyer in IAMBIC B at 15 WPM (words per minute = 60 CPM), with 800 Hz side tone. By default, the transmitter keying signal is positive. The ATTINY85 will automatically power off after 60 seconds into ultra-low power mode to conserve power. The unit draws only a few microamps in this state, making battery power from a single 3V lithium coin cell very practical.

Speed Change

Speed can be changed by pressing and holding the command key while operating the DIT and DAH paddles, in any mode.

DIT reduces speed while DAH increases speed. The keyer plays an alternating sequence of dit and dah while changing speed without keying the transmitter.

Command mode

Pressing the command button without changing speed will switch the keyer into command mode. This will be confirmed with the '?' character. Another press of the same button takes the keyer back into regular keyer mode and will be confirmed by the 'SK' prosign.

During Command Mode the transceiver is never keyed and side tone is always activated. Further functions can be accessed by keying one-letter commands as listed below. In general, changes made in Command Mode will be written to EEPROM after a short delay following input and confirmed by an "R" acknowledgement, or by another short press of the Command button (for some commands). The unit will remain in Command Mode for subsequent commands, timing out to Normal Mode after a few more seconds with an "SK" indication. The keyer can also be returned to Normal Mode with an additional button press.

V -Version

The keyer responds with the current keyer software version number

P -Pitch

Allows modifying the side tone pitch to a higher or lower level. A sequence of dits will be played and the pitch can be modified with the dit and dah paddles. If no paddle is touched for 5 seconds, the acknowledgment signal 'R' is sounded and the mode terminates, writing the new pitch to EEPROM and leaving the user in command mode.

R -Reset

All settings are returned to their default values except for the stored messages in the message EEPROM area. Restored settings include speed and pitch, paddle swap, TX level inversion, side tone Farnsworth setting, and TX keyer settings.



KANGA PRODUCTS

Electronic Kits For The Radio Amateur

U -Tune

The transceiver is keyed for a duration of 20 seconds for tuning purposes. Tuning mode is aborted once either DIT or DAH paddles are touched or the control key is pressed.

A -Iambic A

Keyer sets IAMBIC A as permanent keying mode. The setting is written to EEPROM and an 'R' is sounded to acknowledge the request.

B -Iambic B

Keyer sets IAMBIC B as permanent keying mode. The setting is written to EEPROM and an 'R' is sounded to acknowledge the request.

L -Ultimatic

Sets the keyer into ULTIMATIC mode as permanent keying mode. In Ultimatic mode always the last paddle to be touched is repeated indefinitely when paddles are squeezed. The setting is written to EEPROM and an 'R' is sounded to acknowledge the request.

D -DAH priority mode

Sets the keyer into DAH priority mode as permanent keying mode. In squeezed state a sequence of DAHs is sent. The setting is written to EEPROM and an 'R' is sounded to acknowledge the request. Some of the first generation keyers exhibited this behaviour so the chip can simulate that.

X -Paddle swapping

DIT and DAH paddles are swapped. The setting is written to EEPROM and an 'R' is sounded to acknowledge the request.

S -Side tone toggle

The built-in side tone generator setting is toggled (ON -> OFF or OFF -> ON). NOTE: This setting is only of relevance for regular keying mode. Side tone is always on in Command Mode. The setting is written to EEPROM and an 'R' is sounded to acknowledge the request.

K -TX keying toggle

Toggles the setting of the TX keyer output. In default state the keyer switches the output line when it is in keyer mode. Toggling this setting enables or disables that function. NOTE: Keying is always off in Command mode. The setting is written to EEPROM and an 'R' is sounded to acknowledge the request.

Z -Set Farnsworth pause

Allows setting of an extended inter-character pause, which makes fast keying easier to understand. A series of "Dit-Dah" sequences will be played. Pressing the "Dah" paddle will



KANGA PRODUCTS

Electronic Kits For The Radio Amateur

decrease the Farnsworth intercharacter spacing. Pressing the "Dit" paddle will increase the Farnsworth Intercharacter spacing. If no paddle is touched for 5 seconds, the acknowledgment signal 'R' is sounded and the mode terminates, writing the new setting to EEPROM and leaving the user in command mode. Note that this only affects memory/program playback and transmission. If you desire Farnsworth mode in manual transmission, please manually pause between characters.

F (Flip) -TX level inverter toggle

This function toggles whether the "active" level on the keyer output is VCC or GND. The default is VCC. This setting is dependent upon the attached keying circuit. The setting is written to EEPROM and an 'R' is sounded to acknowledge the request.

W -Query current WPM speed

Keyer responds with current keying speed in WPM.

1, 2, 3, 4 -Record internal messages 1, 2, 3 or 4

The keyer immediately responds with "1" or "2" or "3" or "4" after which a message up to 100 characters can be keyed at current WPM speed. If no paddle is touched for 5 seconds, the acknowledgment signal 'R' is sounded and the mode terminates, writing the new setting to EEPROM and leaving the user in command mode. Choosing "1" or "2" or "3" or "4" but not keying a new message deletes the chosen message buffer content. A command key press during the recording function returns the keyer to command mode, leaving the memory unchanged.

E, I, T and M -Play back internal messages 1 or 2 or 3 or 4

The stored messages 1, 2, 3, or 4 are played back with keying enabled (if configured). A press of the command key aborts the message and immediately returns the keyer to Normal Mode for a QSO, with an "SK" confirmation. After the message plays to completion, the keyer remains in command mode with no "R" indication so another message playback sequence may be started. If no additional message is started, the keyer returns to Normal Mode with an "SK" confirmation.

N -Automatic beacon

The keyer responds with 'N' after which a number between 0 and 9999 can be keyed. After a 5 second timeout the keyer responds by repeating the number and 'R'. Once the keyer returns to keyer mode, the content of message buffer 4 is repeated in intervals of n seconds. The setting is preserved in EEPROM so the chip can be used as a fox hunt keyer. Returning to command mode and entering an interval of 0 (or none at all) stops beacon mode.

0 (zero) -Lock configuration

The 0 (zero) command locks or unlocks the main configuration items but not Version, Pitch, Tune, Callsign Training, WPM Query and Memory Playback functions.



KANGA PRODUCTS

Electronic Kits For The Radio Amateur

C -Callsign trainer

The keyer plays a generated callsign (side tone only no TX) and the user must repeat it. If it was repeated correctly, 'R' is played and the next callsign is given. If a mistake was sensed, the error prosign (8 dits) is sounded and the current callsign is repeated again for the user to try once more. If nothing is keyed for 10 seconds, the keyer returns to command mode.

Speed Change = Command +Paddle
V -Version
P -Pitch
R -Reset
U -Tune
A -Iambic A
B -Iambic B
L -Ultimatic
D -DAH priority mode
X -Paddle swapping
S -Sidetone toggle
K -TX keying toggle
Z -Set Farnsworth pause
F (Flip) - TX level inverter toggle
W -Query current WPM speed
1 , 2, 3, 4 - Record internal messages
E, I, T and M - Play back internal messages
N - Automatic beacon
0 (zero) - Lock configuration