



## Phoenix QRP Pocket Transmatch ATU (PTM-ATU)

Let me be honest, this is the most difficult kit to build that I offer, I would not call it a first time builder's project. It's a lot of ATU in a very small case and needs a good degree of attention to detail when assembling. Take time and read **ALL** the instructions before you start work.

There are many different ATU types L match being one of the most common but although they all provide matching the efficiency can vary a lot, also most do not provide any additional filtering of the signal so pass multiple harmonics that may be present in the radios output.



Enter the transmatch

Well the transmatch is a more complicated ATU than many other designs but it does have a couple of advantages. The transmatch design provides a Band pass type filter which can really help reduce unwanted out of band interference. From an efficiency point of view the transmatch is also very good, much better than the simple traditional L-Match circuits. I also find that a transmatch of this design are faster to tune as there is no need to switch inductors, just two controls to adjust gives a faster match.

This project will build a very small Transmatch, so small it will fit in your pocket.

Let me start by saying I do not take credit for the design or the principal of the Transmatch ATU. The original work seems to have been done by Charlie Lofgren W6JJZ and over the years many variations have been seen, the Kanga QRP Pocket Transmatch combines his work with a resistive SWR bridge to build a very compact unit.

**The pocket transmatch is design to work from 80 -10m**

**Max Power 10 Watts**

**Connectors : BNC Socket**

**Size (without protrusions) 85 x 55 x 27mm**

**Weight : <110 grams**



## Parts List

Check you have all the parts before we begin building

Pocket Transmatch case

Pocket Transmatch Front Panel

Pocket Transmatch PCB (Version 2)

DPST Switch

SPST switch

R2, R3, R4 51 Ohm 2 Watt Resistor

R1 1K 1/4w Resistor

R5 Sensitivity Adjust Trimmer

C1, C2 10nF Disk Capacitor (Yellow 5mm spacing)

C3 10nF Disk Capacitor (2.5mm spacing)

1 x IN5711 Diode

T68-2 Core

1m 0.5mm Enamelled Copper wire (Colour 1)

250mm 0.5mm Enamelled Copper wire (Colour 2)

2 x 270pf Dual Poly Capacitors

1 x 5mm RED LED

2 x BNC Sockets

Socket mounting Hardware 4 x M2.5 4mm var-cap mounting screws

2 x M2.5x12mm Shaft extender Screws

2 x 10mm shaft extenders

Two control knobs

4 x Stick on feet

Connecting Cable 150mm



The Pocket transmatch can be broken down into two sections, the first is a resistive SWR bridge. This is the same circuit as used in our little SWR Indicator bridge kit.

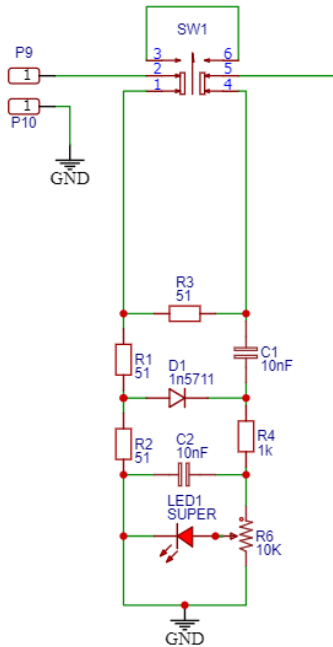

This section can be switched IN or OUT by a two way toggle switch, when in circuit the bridge will light the LED if the antenna is presenting an impedance higher (or Lower) than 50 ohms, if the impedance is matched the LED will go out. Depending on the power level in use the LED can be either too bright and doesn't go out when matched or too dim and hard to see. This circuit has an adjustable sensitive trimmer and it is best to adjust this to suit your most likely used power level.

The second part of the transmatch is the ATU section.

The ATU section uses a T68-2 core comprising of

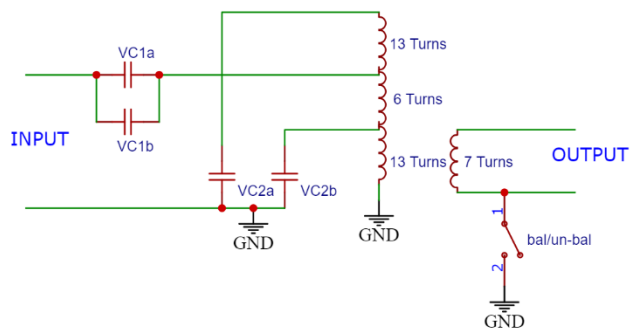

13/6/13 turns on the primary and 7 turns on the secondary, the output can be isolated by means of a grounded toggle switch so the user can use either balance or unbalanced antennas.

The number of turns on the output stage could be adjusted to work with lower impedance antennas ( try just 3 or 4 turns if you want to play) the only problem with reconfiguring this setup is that efficiency can suffer

The Toroidal and its windings are the most difficult part of the build and if not right the ATU will not work correctly.

**The wire for this is supplied in two lengths, the colours may not be as these instructions but you will get two different colour wires. The long wire is for the main winding and the short one for the coupling winding.**



There are many videos on YouTube showing how to wind them that may help. But here are the instructions you need to make the coil. If you are reading this from the paper instructions you may want to look on the instruction page on my web site for a copy in colour that may be easier to follow. Find the first colour wire (its about 1m long) pass it through the toroidal as shown here, leave the one end about 50mm long. This counts as one turn, every time the wire passes through the core it counts as a turn,



Continue to wind the wire for a total of 13 turns as in the picture on the right.



Note the direction that I have wound it.

Now we need to form a loop.

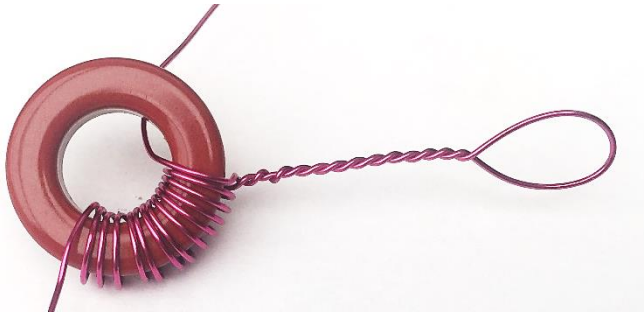

Form a loop about 30-50mm long as shown here, feed the wire back into the core and wind for another 6 turns.

The toroidal should be looking like this now.

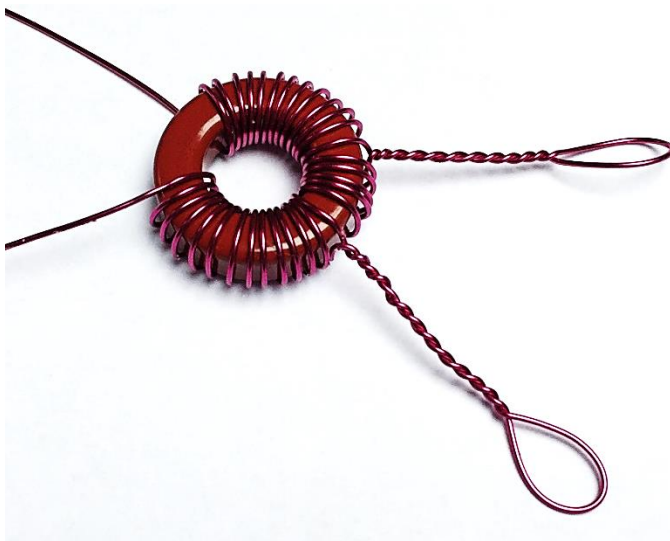
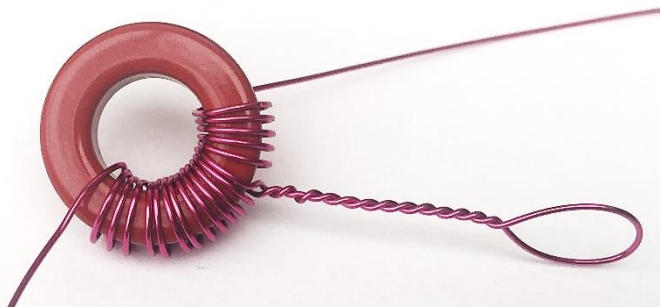

Now form another loop as before and then continue to wind the toroidal with another 13 turns.

So far we should have 13 turns then a loop followed by 6 turns and a loop and a final 13 turns. Double check that you have this correct before we move on. A good way to count the turns is to use a digital camera (phone) and take a picture, zoom into the picture on the screen and then you can count the turns

much easier than trying to count them on such a small core.

That completes the main windings but we still have one more winding to do.

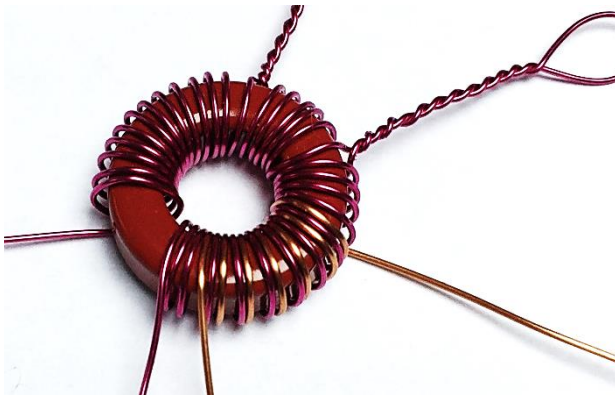

Now find the 2<sup>nd</sup> coloured wire, it is much shorter than the first wire (only about 25cm)

If you are using paper instructions you may find it hard to see this picture so look on my website for a colour copy if that helps.

Now this winding is only 7 turns but you need to wind them BETWEEN the winding already on the core, start 3 turns from the end of the coil and very carefully wind this new coil so the copper wire is between the turns of the first

coil. Look carefully at the picture and make sure you wind the second coil in the same direction as the picture shows.

Hopefully you will produce a nice neat set of windings, take your time this is a very important part of the transmatch and the performance will be reduced if this is not done correctly.

Now we can fit the toroidal, you first can tin the leads, **this is the hardest part of the kit** to fit and probably the most important part to get right. Please follow the instructions for this part unless you are a super confident experienced builder and know what you're doing.

The enamel on the wires is a special enamel that will burn off if treated correctly. You need a good soldering iron that keeps its heat for this, you can help it by scraping the wire or lightly sanding the wires from the toroidal first to break the enamel insulation. When tinning these wires you will need to apply the soldering iron and solder for about 10 secs or so, normally a puff of smoke will come off the wire when the enamel burns off and the solder will then flow over the wires. Don't breath in these fumes, I am sure that they are not good for you. In fact all solder fumes are to be avoided. Make sure you have plenty of ventilation in the work area.

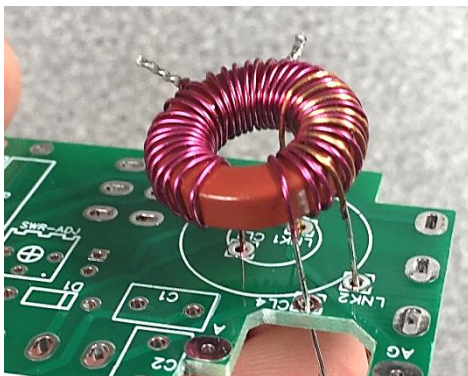

The main winding has 4 connection points, two of which are the loops, we can ignore them for now, the earth side of the winding is nearest the 7 turn coupling coil. The earth side of the winding goes into the pad marked CL4 and the 'hot' end goes into CL1 the coupling coil goes to LNK2 and LNK1.

Solder the 4 wires making sure the toroidal is sat flush on the board and

there is no slack in the leads. You may need to apply the soldering iron for about 10 secs to burn off any enamel on the wire, a fresh blob of solder helps too.

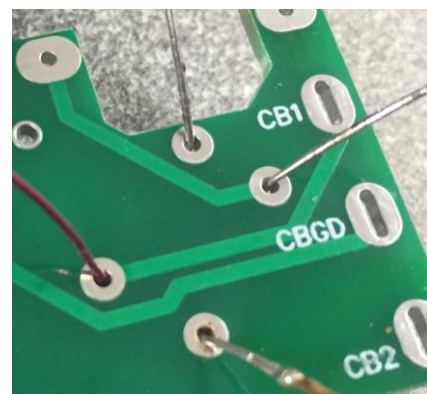
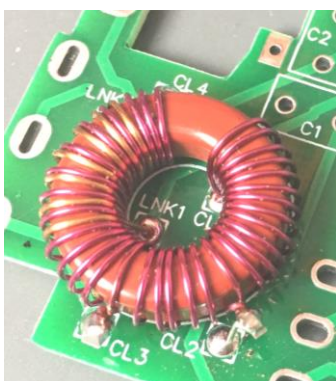



I haven't forgotten to tell you to solder the loops, hold on a moment from soldering them.

Next I suggest fitting the three 2 watt resistors, you need to keep the off cuts from these resistors.

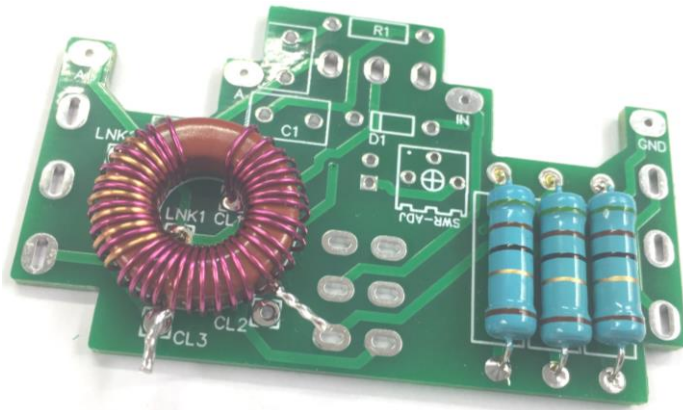

These off cuts are what we will use to connect the loops to the main PCB, take two cut leads and make short walking sticks.



Uses these sticks to drop through the PCB over the two loop ends of the main windings and solder them to the loops

and to the bottom of the board, now you can trim back the loop pig tails.

Now its worthwhile checking for continuity for both windings

Now we can fit the remaining parts, these are an easier job.

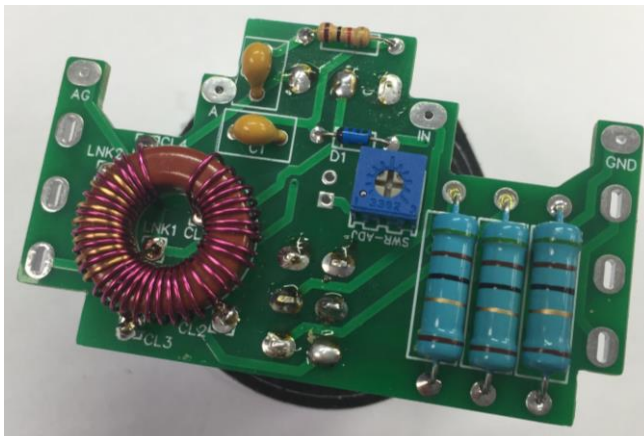
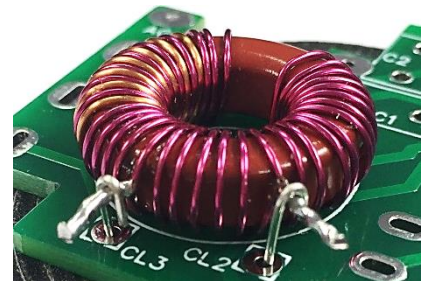

Leave the switches for now and solder all the other board mounting parts (NOT THE LED)

Fit the two yellow 10nf capacitors (C1 & C2), next C3 which is not shown on the picture here but its next to the SWR -ADJ trimmer. Then the 1K resistor (R1), the 1N5711 diode (D1) and finally the sensitivity trimmer.

Now we need to fit the switches, **TAKE CARE AND FOLLOW THESE INSTRUCTIONS.** There are two switches but you can't mix them up, it is important that you fit these so that the switch contacts are **just** flush with the back of the board. Do NOT push the switch right down onto the PCB. The SPST switch may have a longer center pin, that's fine but the outer pins should be just flush with the back of the board. Make sure the switch sits straight and not leaning to one side.

The second switch is mounted just the same, just have the switches legs sit flush with the back of the PCB, you MUST NOT push the switch right down on the PCB. Make sure it sits nice and straight.

Now we need to prepare the two variable capacitors.

**IMPORTANT** read the following twice and look at the photos below **BEFORE** you cut the leads. Be **100%** sure what you're doing at this stage. Check twice, cut once!

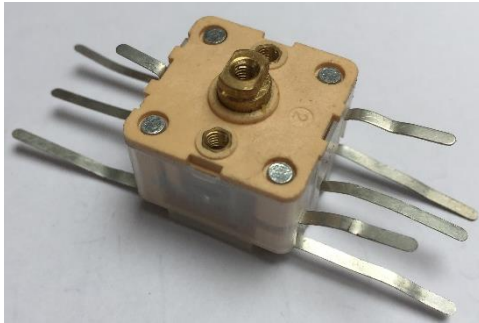

On one side of the capacitor there are 4 pins, the other side has 5. Make sure you identify each side

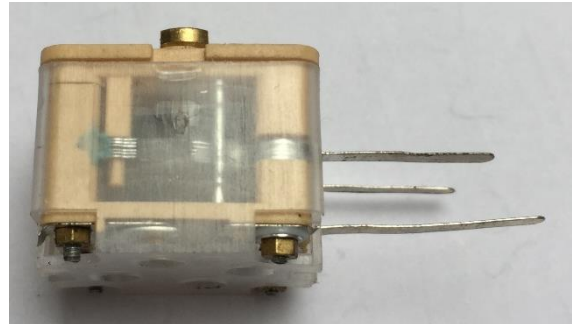

correctly, once sure snip off all the legs on the side with **4** pins.

Now on the 5 pin side half way down the body of the capacitor you will see one lead on the left and on the right, we **NEED** these so do not cut them! Under these leads we have 3 leads in a row, we only want the center lead, the other two need to be snipped off, snip them off right up against the body. Check twice before cutting them that you have the right ones, look at the other pictures below in the next stages to be sure you know which ones to cut.

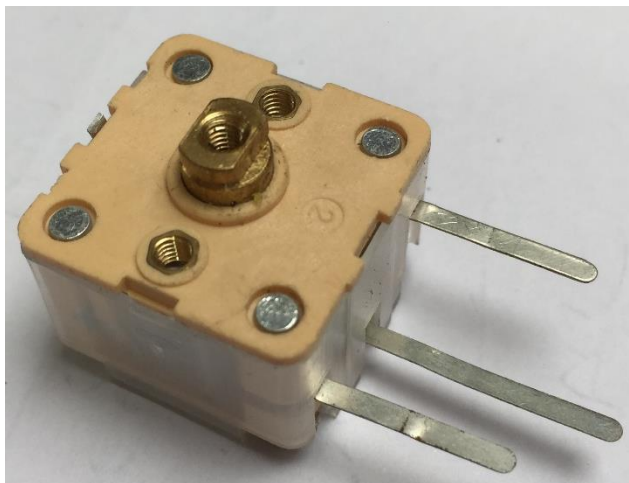

If you have a suitable capacitance meter check between the center pin and the two outer pins, you should find that you have about 250-270pf when you adjust the capacitor between each pin and center.

Now we can fit the shaft extenders to the capacitors, you will find 10mm black extender tube and 2.5mm x 12mm screw, when tightening the extender be careful not to damage the internals of the capacitor by applying too much force to the body of the capacitor. Use a pair of cutters or needle

nose pliers to hold the small brass shaft on its two flats when tightening the 12mm screw.

On the back of the capacitor there are 4 trimmers, we are not using any of them but I still like to set them fully open (Un-Meshed). If you don't do this it's not going to cause a problem but I still recommend doing this.

When the capacitors are ready we can move on. Attach the two capacitor to the front plate with the 2.5mm short screws provided.

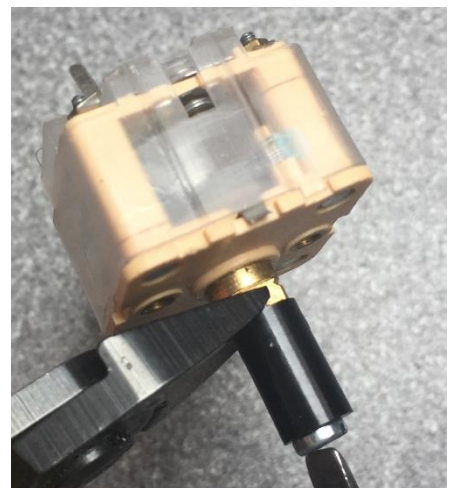



Fold back the three remaining terminals from each capacitor as shown in this picture.

Now another important step. You will find a short length of very thin foam tape, cut this to fit the back of these capacitors. One side of the foam has a paper backing, the other side has a plastic peelable backing, remove the plastic backing and stick the foam to the back of the two capacitors. This foam makes sure that we get no short circuits from back of the PCB solder points when we bolt it all together. Make sure the tape is a little larger

than the base of the capacitors.

We now can start putting things together. Drop the LED into place on the PCB from the switch side, the **Make sure the long leg of the LED goes into ROUND hole.**

Take care and put the main PCB over the back of the capacitors so that the 3 pins from each capacitor pass through the fixing slots for them on the PCB. Important! Check the Red LED was put through the PCB from the side with the switches fitted first, DO NOT solder the LED at this stage. Make sure it doesn't get trapped or bent when you're doing this stage.

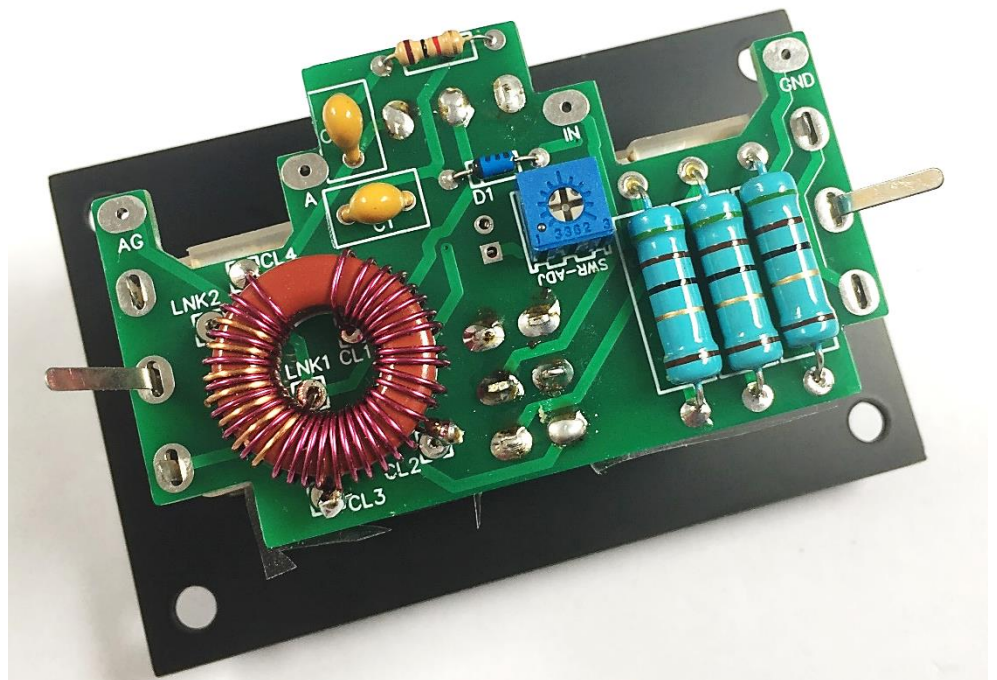

Push the PCB down onto the back of the Capacitors to make the assembly as compact as possible (if it's not right down the ATU will not fit into it case!) make sure the tape is in place still.

Solder the capacitor legs and trim. Make sure the LED is protruding through the front plate and solder the Legs on the PCB, the legs will just be visible but the board holes are fully plated and so they will solder fine.



Now we can move onto the case.

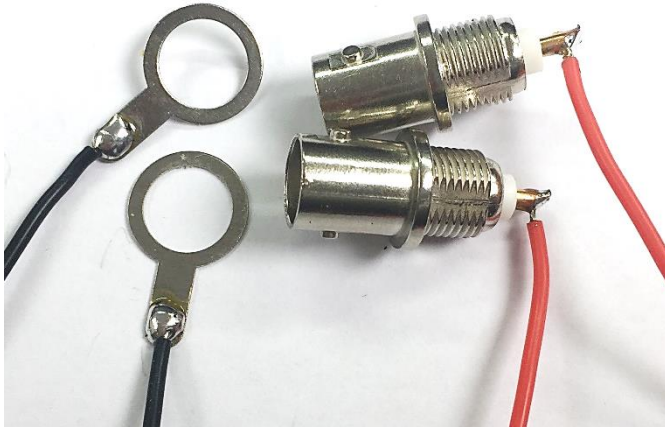

First solder the supplied wires to the BNC's and their earth tags. Now this is a tight fit in the case so solder the center pin of the BNC socket so the wire comes off at 90 degrees to the brass pin (see Photos). This is important or the wires will stop the board fitting into the case properly.

Now we need to fit these to the case. The first job is to get the case ready to allow the BNC's to be tighten up. The case is pre-drilled but if you look inside you will see two plastic PCB guides right next to the BNC mounting holes. You need to snip these plastic PCB guides off flush. I use a small pair of flush wire trimmers to do this.



If these guides are not trimmed flush the BNC sockets will not mount correctly. A sharp pair of flush cut wire trimmers do the job quickly and easily.

The photos here may not reproduce well when printed, if unsure look on the instruction via the web site so you can see better quality images.

Now fit the two BNC sockets, the earth tags should be arranged so they are both nearest to the sides of the case and pointing downwards.

Make sure the BNC sockets are nice and tight so they do not turn when you attach plugs.

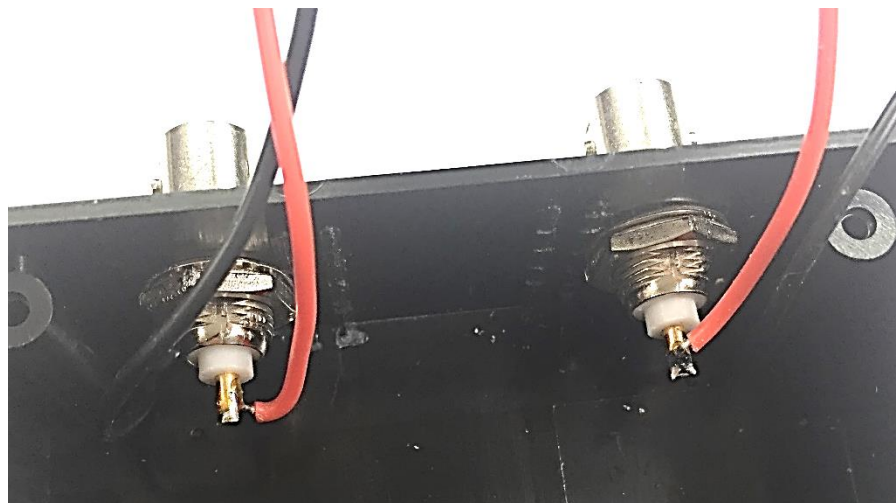



Trim and attach the wires from the sockets to the main PCB. Keep these wires as short as possible.

In the kit you will find a large green spacer. When the first version of this ATU was made the manufacture supplied me with variable capacitors that were a millimetre or two thinner than their new version. That extra couple of mm made a difference, the ATU assembly now touched the back of the box when the front was fitted. The manufacture told me that new stock would be the new size so I had to think of a

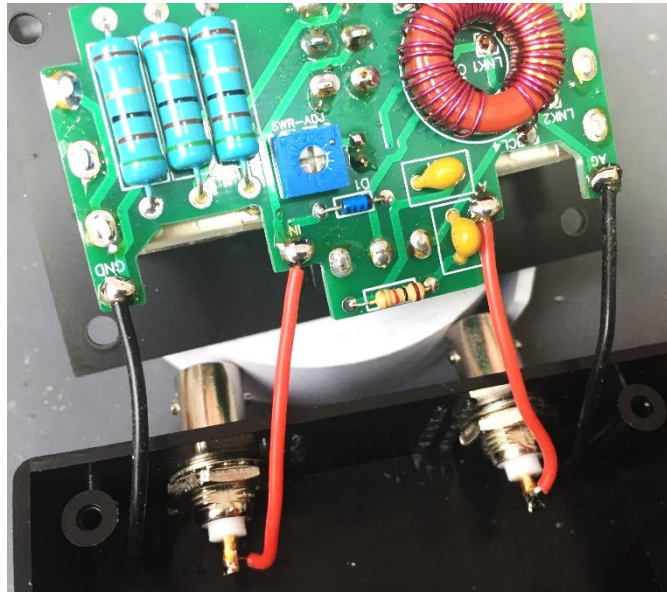

method to raise the front but by only a small amount to make the front panel flush with the edge of

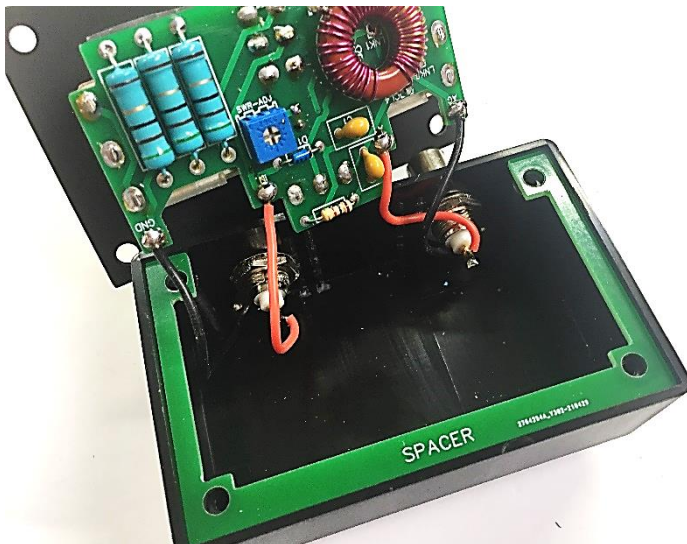

the box, the solution turned out simple. I used some 1.5mm thick washers to start with, it worked but it was hard to keep them in place while fitting the front to the case. In the end I had a spacer made that drops in between the front panel and the case. Make sure you drop this in before tightening the front panel down.

Now we can drop the front on to the case and use the four 8mm self-tapping screws to fasten the front to the case.

The switches can now have their nuts attached although this is more cosmetic than necessary. Fit the knobs and the stick on feet (if you want to use them)





## Using the Pocket Transmatch

Well done on finishing the transmatch. Now to test it, connect your antenna to the ANT side of the ATU and the transmitter to the TX side. Tune to the frequency you want to use on the radio. Do not transmit yet. Put the switch on the ATU to OPER and if using a coax fed antenna set the other switch to 'Un-Bal', if using a balance feeder then select 'BAL'. Adjust the two ATU controls to find the spot with maximum band noise, normally this will be very noticeable. Often you will find that this is just about the right spot for a match. Reduce the TX power to 5 watts or less and switch the ATU to 'Tune'. Now supply carrier. Now adjust the two controls on the ATU to get the LED to go out (or become as dim as possible) this normally only takes a few seconds. When the LED is out you have achieved a match and the switch can be changed from Tune to OPER.

Now if your radio has a built in SWR meter you can see how good a match you have and if you wish you can tweak the value by making small adjustments to the ATU. Normally when the LED is out your good to go and there is no real advantage in trying to get the last bit of match out of the tuner. Do remember just because you have a 1:1 match that it doesn't mean you have a good antenna, a dummy load will give you a perfect match. You can adjust the power level up to around 10 watts when you have attached a match.

After using the tuner a while you will get to trust the LED as a SWR indicator and find no need to look at the built in SWR meter if your radio has one.

## Trouble shooting

If you follow the instructions you should not really have many problems. The most common are that the LED doesn't work. This is normally one of two things

- 1) The Sensitivity control has been set too low for the LED (internal Trimmer) I like mine set to max brightness, at 5 watts I find it will still go out completely when a match is found.
- 2) The LED was put in backwards!

No Match on antenna on certain bands

Sometimes an antenna will just not give you a match on certain bands, sometimes your antenna will be a half wave on certain frequencies and that will be a very high impedance that most tuners will find hard to match, for example a  $\frac{1}{4}$  wave on 40m is a half wave on 20 and a full wave on 10m. You may not get a match on these bands with such an antenna. If that is the case try adding or shortening the antenna by a few feet, that can make a big difference to the impedance.

LED lights on TX when in OPER mode.

With some antennas on the higher bands you may notice the LED light dimly when the ATU is OPER mode, this is due to stray RF pickup on the LED circuit and is not a problem. The newer Ver2 PCB has a extra capacitor (C3) that will reduce this to the point it may not be noticeable anyway now.

Another point worth noting, the SWR LED may indicate a min but the built in SWR meter on your radio may show min at a slightly different ATU setting. The length of 'patch' lead between the ATU and the radio can cause this, if you have a built in SWR indicator on the radio then adjust the tuner to give the lowest level there. The SWR LED is intended for matching when you do not have additional indication available.

I hope that you enjoyed building the Pocket Transmatch and that it performs as you expect.

Thank you Paul MOBMAN